

Technical Information Manual

Revision n. 8
5 October 2009

**V1190 A/B
VX1190 A/B**
MULTIHIT TDCs
MANUAL REV.8

NPO:
00104/03:V1X90.MUTx/08

CAEN will repair or replace any product within the guarantee period if the Guarantor declares that the product is defective due to workmanship or materials and has not been caused by mishandling, negligence on behalf of the User, accident or any abnormal conditions or operations.

CAEN declines all responsibility for damages or injuries caused by an improper use of the Modules due to negligence on behalf of the User. It is strongly recommended to read thoroughly the CAEN User's Manual before any kind of operation.



CAEN reserves the right to change partially or entirely the contents of this Manual at any time and without giving any notice.

Disposal of the Product

The product must never be dumped in the Municipal Waste. Please check your local regulations for disposal of electronics products.



TABLE OF CONTENTS

1. GENERAL DESCRIPTION.....	10
1.1. OVERVIEW	10
1.2. BLOCK DIAGRAM	11
2. FUNCTIONAL DESCRIPTION.....	12
2.1. HPTDC OVERVIEW	12
2.1.1. TDC chips architecture	12
2.2. OPERATING MODE SELECTION	14
2.3. CONTINUOUS STORAGE MODE	14
2.4. TRIGGER MATCHING MODE	15
2.4.1. Timing constraints	17
2.5. INTEGRAL-NON-LINEARITY COMPENSATION	18
3. TECHNICAL SPECIFICATIONS.....	22
3.1. PACKAGING.....	22
3.2. POWER REQUIREMENTS	22
3.3. FRONT PANEL.....	23
3.4. EXTERNAL CONNECTORS.....	25
3.4.1. INPUT connectors.....	25
3.4.2. CONTROL connector	26
3.4.3. EXTERNAL TRIGGER connectors.....	26
3.5. OTHER FRONT PANEL COMPONENTS	27
3.5.1. Displays	27
3.6. INTERNAL HARDWARE COMPONENTS	27
3.6.1. Switches.....	27
3.7. TECHNICAL SPECIFICATIONS TABLE	29
4. OPERATING MODES	30
4.1. INSTALLATION.....	30
4.2. POWER ON SEQUENCE	30
4.3. POWER ON STATUS	31
4.4. ADDRESSING CAPABILITY.....	31
4.4.1. Addressing via Base Address.....	32
4.4.2. Base addressing examples	33
4.4.3. MCST/CBLT addressing.....	33
4.4.4. MCST/CBLT addressing examples.....	35
4.5. INTERRUPTER CAPABILITY	36
4.5.1. Interrupt Status/ID.....	36
4.5.2. Interrupt Level.....	36

4.5.3.	<i>Interrupt Generation</i>	36
4.5.4.	<i>Interrupt Request Release</i>	36
4.6.	TRIGGER MATCHING MODE DATA TRANSFER.....	37
4.6.1.	<i>D32 OUTPUT BUFFER readout (Trigger Matching)</i>	37
4.6.2.	<i>BLT32/64 OUTPUT BUFFER readout with Bus Error and Event Aligned BLT disabled</i>	37
4.6.3.	<i>BLT32/64 OUTPUT BUFFER readout with Bus Error enabled</i>	38
4.6.4.	<i>BLT32/64 OUTPUT BUFFER readout with Event Aligned BLT enabled</i>	39
4.6.5.	<i>BLT32/64 OUTPUT BUFFER readout with both Event Aligned BLT and Bus Error enabled</i>	40
4.6.6.	<i>CBLT32/64 OUTPUT BUFFER readout</i>	40
4.6.7.	<i>D32 and BLT32/MBLT readout with Event FIFO enabled</i>	41
4.7.	COUNTINUOUS STORAGE MODE DATA TRANSFER.....	42
4.7.1.	<i>D32 OUTPUT BUFFER readout (Continuous Storage)</i>	42
4.7.2.	<i>BLT32/64 OUTPUT BUFFER readout (Continuous Storage)</i>	43
4.8.	RESET LOGIC.....	43
4.8.1.	<i>Software and Hardware CLEAR</i>	43
4.8.2.	<i>Software RESET</i>	44
4.8.3.	<i>Hardware RESET</i>	44
4.8.4.	<i>Software Event Count RESET</i>	44
4.8.5.	<i>Hardware Bunch Count RESET</i>	44
4.9.	FIRMWARE UPGRADE.....	45
5.	OPERATING CODES	46
5.1.	PROGRAMMING CAPABILITY.....	46
5.2.	ACQUISITION MODE OPCODES.....	49
5.2.1.	<i>Set Trigger Matching Mode (CODE 00xx)</i>	49
5.2.2.	<i>Set Continuous Storage Mode (CODE 01xx)</i>	49
5.2.3.	<i>Read acquisition mode (CODE 02xx)</i>	49
5.2.4.	<i>Set keep_token (CODE 03xx)</i>	49
5.2.5.	<i>Clear keep_token (CODE 04xx)</i>	49
5.2.6.	<i>Load default configuration (CODE 05xx)</i>	50
5.2.7.	<i>Save User configuration (CODE 06xx)</i>	50
5.2.8.	<i>Load User configuration (CODE 07xx)</i>	50
5.2.9.	<i>Set auto load User configuration (CODE 08xx)</i>	50
5.2.10.	<i>Set auto load default configuration (CODE 09xx)</i>	50
5.3.	TRIGGER OPCODES.....	51
5.3.1.	<i>Set window width (CODE 10xx)</i>	51
5.3.2.	<i>Set window offset (CODE 11xx)</i>	51
5.3.3.	<i>Set extra search margin (CODE 12xx)</i>	51
5.3.4.	<i>Set reject margin (CODE 13xx)</i>	51
5.3.5.	<i>Enable subtraction of trigger time (CODE 14xx)</i>	52
5.3.6.	<i>Disable subtraction of trigger time (CODE 15xx)</i>	52
5.3.7.	<i>Read trigger configuration (CODE 16xx)</i>	52
5.4.	TDC EDGE DETECTION AND RESOLUTION OPCODES.....	52
5.4.1.	<i>Set edge detection configuration (CODE 22xx)</i>	52
5.4.2.	<i>Read edge detection configuration (CODE 23xx)</i>	52
5.4.3.	<i>Set LSB of leading/trailing edge (CODE 24xx)</i>	53
5.4.4.	<i>Set leading time and width resolution when pair (CODE 25xx)</i>	53
5.4.5.	<i>Read resolution (CODE 26xx)</i>	54
5.4.6.	<i>Set channel dead time between hits (CODE 28xx)</i>	54
5.4.7.	<i>Read channel dead time between hits (CODE 29xx)</i>	55

5.5.	TDC READOUT OPCODES	55
5.5.1.	Enable TDC Header and Trailer in readout (CODE 30xx).....	55
5.5.2.	Disable TDC Header and Trailer in readout (CODE 31xx)	55
5.5.3.	Read TDC Header and Trailer status (CODE 32xx).....	55
5.5.4.	Set maximum number of hits per event (CODE 33xx).....	56
5.5.5.	Read maximum number of hits per event (CODE 34xx).....	56
5.5.6.	Enable TDC error mark (CODE 35xx).....	56
5.5.7.	Disable TDC error mark (CODE 36xx)	57
5.5.8.	Enable bypass TDC if error (CODE 37xx).....	57
5.5.9.	Disable bypass TDC if error (CODE 38xx).....	57
5.5.10.	Enable TDC internal error type (CODE 39xx).....	57
5.5.11.	Read enabled TDC internal error type (CODE 3Axx).....	57
5.5.12.	Set effective size of readout FIFO (CODE3Bxx)	58
5.5.13.	Read effective size of readout FIFO (CODE3Cxx).....	58
5.6.	CHANNEL ENABLE OPCODES	58
5.6.1.	Enable channel nn (CODE 40nn).....	58
5.6.2.	Disable channel nn (CODE 41nn).....	58
5.6.3.	Enable all channels (CODE 42xx).....	59
5.6.4.	Disable all channels (CODE 43xx)	59
5.6.5.	Write enable pattern (CODE 44xx)	59
5.6.6.	Read enable pattern (CODE 45xx).....	59
5.6.7.	Write enable pattern 32 (CODE 460n).....	60
5.6.8.	Read enable pattern 32 (CODE 470n)	60
5.7.	ADJUST OPCODES.....	61
5.7.1.	Set global offset (CODE 50xx)	61
5.7.2.	Read global offset (CODE 51xx).....	61
5.7.3.	Set channel nn adjust (CODE 52nn).....	61
5.7.4.	Read channel nn adjust (CODE 53nn)	61
5.7.5.	Set RC adjust of TDC n (CODE 540n)	61
5.7.6.	Read RC adjust of TDC n (CODE 550n).....	61
5.7.7.	Save RC adjust on EEPROM (CODE 56xx).....	62
5.8.	MISCELLANEOUS.....	62
5.8.1.	Read ID code of TDC n (CODE 600n).....	62
5.8.2.	Read firmware rev. of microcontroller (CODE 61xx).....	62
5.8.3.	Reset PLL and DLL (CODE 62xx)	62
5.9.	ADVANCED	62
5.9.1.	Write word nn into the Scan Path Setup (CODE 70nn).....	62
5.9.2.	Read word nn into the Scan Path Setup (CODE 71nn)	63
5.9.3.	Load the Scan Path Setup (CODE 72xx).....	63
5.9.4.	Reload the default Scan Path Setup (CODE 73xx).....	63
5.9.5.	Read errors in the TDC n status (CODE 740n).....	63
5.9.6.	Read the DLL LOCK bit of the TDC n (CODE 750n).....	63
5.9.7.	Read the TDC n status (CODE 760n).....	63
5.9.8.	Load the Scan Path Setup in the TDC n (CODE 770n).....	63
5.10.	TEST AND DEBUG	64
5.10.1.	Write EEPROM (CODE C0xx).....	64
5.10.2.	Read EEPROM (CODE C1xx)	64
5.10.3.	Revision and Date Microcontroller firmware (CODE C2xx).....	64
5.10.4.	Write Spare (CODE C3xx)	65
5.10.5.	Read Spare (CODE C4xx).....	65
5.10.6.	Enable Test Mode (CODE C5xx)	65
5.10.7.	Disable Test Mode (CODE C6xx)	65
5.10.8.	Set TDC Test output (CODE C7xn).....	65

5.10.9.	Set DLL Clock (CODE C8xx).....	66
5.10.10.	Read TDC Setup Scan Path (CODE C9xn).....	66
6.	VME INTERFACE.....	67
6.1.	REGISTER ADDRESS MAP.....	67
6.1.1.	Configuration ROM.....	68
6.2.	OUTPUT BUFFER REGISTER.....	69
6.2.1.	Trigger Matching Mode.....	69
6.2.2.	Continuous Storage Mode.....	71
6.2.3.	Filler.....	71
6.3.	CONTROL REGISTER.....	72
6.4.	STATUS REGISTER.....	74
6.5.	ADER 32 REGISTER (ONLY FOR VX1190 A/B).....	75
6.6.	ADER 24 REGISTER (ONLY FOR VX1190 A/B).....	75
6.7.	ENABLE ADER REGISTER (ONLY FOR VX1190 A/B).....	76
6.8.	INTERRUPT LEVEL REGISTER.....	76
6.9.	INTERRUPT VECTOR REGISTER.....	76
6.10.	GEO ADDRESS REGISTER.....	77
6.11.	MCST BASE ADDRESS REGISTER.....	77
6.12.	MCST/CBLT CONTROL REGISTER.....	78
6.13.	MODULE RESET REGISTER.....	78
6.14.	SOFTWARE CLEAR REGISTER.....	78
6.15.	SOFTWARE EVENT RESET REGISTER.....	78
6.16.	SOFTWARE TRIGGER REGISTER.....	78
6.17.	EVENT COUNTER REGISTER.....	79
6.18.	EVENT STORED REGISTER.....	79
6.19.	ALMOST FULL LEVEL REGISTER.....	79
6.20.	BLT EVENT NUMBER REGISTER.....	80
6.21.	FIRMWARE REVISION REGISTER.....	80
6.22.	TESTREG REGISTER.....	80
6.23.	OUT_PROG CONTROL REGISTER.....	81
6.24.	MICRO REGISTER.....	81
6.25.	MICRO HANDSHAKE REGISTER.....	81
6.26.	DUMMY32 REGISTER.....	82
6.27.	DUMMY16 REGISTER.....	82
6.28.	SELECT FLASH REGISTER.....	82
6.29.	FLASH MEMORY.....	82
6.30.	COMPENSATION SRAM PAGE REGISTER.....	82

6.31.	EVENT FIFO.....	83
6.32.	EVENT FIFO STORED REGISTER.....	83
6.33.	EVENT FIFO STATUS REGISTER.....	83
6.34.	COMPENSATION SRAM.....	84
APPENDIX A: FLASH MEMORY ACCESSES		85
APPENDIX B: DEFAULT SET UP SCAN PATH.....		90
REFERENCES.....		94

LIST OF FIGURES

FIG. 1.1:	MOD. V1190 A BLOCK DIAGRAM.....	11
FIG. 2.1:	TDC SIMPLIFIED BLOCK DIAGRAM	12
FIG. 2.2:	PULSE DETECTION.....	13
FIG. 2.3:	CONTINUOUS STORAGE.....	15
FIG. 2.4:	MOD. V1190 A/B TRIGGER MATCHING MODE TIMING DIAGRAM.....	16
FIG. 2.5:	TRIGGER MATCHING WINDOWS OVERLAP	17
FIG. 2.6:	STORAGE OF HITS OCCURRED PRIOR TRIGGERING	17
FIG. 2.7:	STORAGE OF HITS WHICH MAY OCCUR AFTER TRIGGERING	18
FIG. 2.8	INL I/O CHARACTERISTIC	19
FIG. 2.9	INL TRACE @ 200PS	20
FIG. 2.10	INL TRACE @ 100PS	20
FIG. 2.11	RMS EXAMPLE @ 100PS (T4=85NS) AFTER INL COMPENSATION.....	21
FIG. 2.12	INL FOR 100 PS AFTER INL COMPENSATION	21
FIG. 3.1:	MODEL V1190 A/V1190 B FRONT PANELS	23
FIG. 3.2:	INPUT CONNECTOR PIN ASSIGNMENT.....	24
FIG. 3.3:	INPUT CONNECTOR CABLING (MOD. A967 CABLE ADAPTER).....	25
FIG. 3.4:	CONTROL CONNECTOR PIN ASSIGNMENT	26
FIG. 3.5:	COMPONENT LOCATION (V1190 A).....	28
FIG. 4.1:	BASE ADDRESSING: EXAMPLE 1	33
FIG. 4.2:	MCST/CBLT ADDRESSING EXAMPLE.....	35
FIG. 4.3	EXAMPLE OF BLT DATA TRANSFER WITH BERR AND EVENT ALIGNED BLT DISABLED.....	38
FIG. 4.4	EXAMPLE OF BLT DATA CYCLE WITH BERR ENABLED AND EVENT ALIGNED BLT DISABLED.....	38
FIG. 4.5	EXAMPLE OF BLT DATA CYCLE WITH BERR DISABLED AND EVENT ALIGNED BLT ENABLED.....	39
FIG. 4.6	EXAMPLE OF BLT DATA TRANSFER WITH BERR AND EVENT ALIGNED BLT ENABLED.....	40
FIG. 4.7	MEB READOUT WITH EVENT FIFO ENABLED.....	42

FIG. 5.1: MICRO REGISTER	46
FIG. 5.2: OUTPUT BUFFER: THE TEST WORD	65
FIG. 6.1: OUTPUT BUFFER: THE GLOBAL HEADER	69
FIG. 6.2: OUTPUT BUFFER: THE TDC HEADER	70
FIG. 6.3: OUTPUT BUFFER: THE TDC MEASUREMENT	70
FIG. 6.4: OUTPUT BUFFER: THE TDC TRAILER	70
FIG. 6.5: OUTPUT BUFFER: THE TDC ERROR	70
FIG. 6.6: OUTPUT BUFFER: THE EXTENDED TRIGGER TIME TAG	70
FIG. 6.7: OUTPUT BUFFER: THE TRAILER	70
FIG. 6.8: OUTPUT BUFFER: THE FILLER	71
FIG. 6.9: CONTROL REGISTER.....	72
FIG. 6.10: STATUS REGISTER.....	74
FIG. 6.11: ADER 32 REGISTER.....	75
FIG. 6.12: ADER 24 REGISTER.....	75
FIG. 6.13: ENABLE ADER REGISTER	76
FIG. 6.14: INTERRUPT LEVEL REGISTER	76
FIG. 6.15: INTERRUPT VECTOR REGISTER	76
FIG. 6.16: GEOGRAPHICAL ADDRESS REGISTER	77
FIG. 6.17: MCST/CBLT ADDRESS REGISTER	77
FIG. 6.18: MCST/CBLT CONTROL REGISTER.....	78
FIG. 6.19: TRIGGER COUNTER REGISTER.....	79
FIG. 6.20: EVENT STORED REGISTER.....	79
FIG. 6.21: ALMOST FULL LEVEL REGISTER	79
FIG. 6.22: BLT EVENT NUMBER REGISTER	80
FIG. 6.23 FIRMWARE REVISION REGISTER	80
FIG. 6.24: TESTREG REGISTER	80
FIG. 6.25: OUT_PROG REGISTER	81
FIG. 6.26: MICRO REGISTER	81
FIG. 6.27: MICRO HANDSHAKE REGISTER	81
FIG. 6.28: SELECT FLASH REGISTER	82
FIG. 6.29: COMPENSATION SRAM PAGE REGISTER	83
FIG. 6.30: EVENT FIFO REGISTER	83
FIG. 6.31: EVENT FIFO STORED REGISTER	83
FIG. 6.32: EVENT FIFO STATUS REGISTER	83
FIG. 6.33: COMPENSATION SRAM ARCHITECTURE	84
FIG. A.1: FLASH ARCHITECTURE.....	85

LIST OF TABLES

TABLE 3.1: MODEL V1190 A/B POWER REQUIREMENTS	22
TABLE 3.2 : MODEL V1190 A/B TECHNICAL SPECIFICATIONS.....	29
TABLE 4.1: MODULE RECOGNISED ADDRESS MODIFIER.....	32
TABLE 4.2: CLEAR/RESET EFFECT ON THE MODEL V1190 A/B REGISTERS	45
TABLE 5.1: OPERATING CODES LIST	47
TABLE 6.1: ADDRESS MAP FOR THE MODEL V1190 A/B	67
TABLE 6.2: ROM ADDRESS MAP FOR THE MODEL V1190 A/B	68
TABLE B.2: DEFAULT SET UP SCAN PATH	90

1. General description

1.1. Overview

The Model V1190 A is a 1-unit wide VME 6U module that houses 128 independent Multi-Hit/Multi-Event Time to Digital Conversion channels. The unit houses 4 High Performance TDC chips, developed by CERN/ECP-MIC Division. Resolution can be set at 100 ps (19 bit dynamics, 52 μ s FSR), 200 ps (19 bit dynamics, 104 μ s FSR) or 800 ps (17 bit dynamics, 104 μ s FSR).

The Model V1190 B is a 1-unit wide VME 6U module that houses 64 independent Multi-Hit/Multi-Event Time to Digital Conversion channels. The unit houses 2 High Performance TDC chips and shares most of its features with the V1190 A.

The VX1190 A and the VX1190 B are the VME64X mechanics versions of the Mod. V1190 A and of the Mod. V1190 B respectively. They provide all the features of the std. VME versions, moreover they support the GEOgraphical Address.

The CERN/ECP-MIC HPTDC is a General Purpose time-to-digital converter, with 32 channels per chip. The chips can be enabled to the detection of the rising and/or falling edges and of the pulses width.

The data acquisition can be programmed in "EVENTS" ("TRIGGER MATCHING MODE" with a programmable time window: the so called *match window*) or in "CONTINUOUS STORAGE MODE".

The board houses a 32 kwords deep Output Buffer, that can be readout via VME (as single data, Block Transfer and Chained Block Transfer) in a completely independent way from the acquisition itself.

The TDCs' programming is performed via a microcontroller that implements a high-level interface towards the User in order to mask the TDCs' hardware.

Both the Mod. V1190 A and the Mod. V1190 B fit into standard, V430 and VME64x VMEbus crates.

The Mod. VX1190 A and the Mod. VX1190 B require VME64x VMEbus crates.

The module accepts both ECL and LVDS inputs on the TDC inputs.

The unit accepts the following CONTROL signals (ECL differential, 110 Ω) in common to all channels:

TRG: a common TRIGGER input;

CRST: allows the TDCs' Bunch Count Reset (see § 4.8.5)¹;

CLK: allows to provide an external Clock to the board;

CLR: erases data from the Output Buffer and performs TDCs global reset;

L2A/L2R: Level 2 Accept/Reject (2nd level trigger, not yet implemented);

AUX: auxiliary input (not yet implemented).

¹ Refer also to [4] J. Christiansen, "HPTDC Version 2.0", for details

The TRIGGER can be also sent as NIM signal on a double (bridged) LEMO00 connector. An ECL output, OUT_PROG, whose function can be programmed (see § 6.23), is also available on the CONTROL Bus.

Six front panel LEDs show the status of the unit:

- DTACK lights up each time the module generates the VME signal DTACK;
- PWR lights up when the module is correctly supplied
- TERM ON lights up when all the lines of the CONTROL bus are terminated;
- FULL lights up when the memory is full;
- ERROR lights up when a global error in the TDCs occurs;
- DATA READY lights up when the Event/Data Ready condition occurs (see § 6.4).

The module houses a VME INTERRUPTER [2]: the interrupt is generated as soon as the buffer is almost full (programmable).

The module works in A24/A32 mode.

The internal registers are available in D16 / D32 mode, while the data buffer is available in D32, BLT32 or MBLT64. The module supports also the Chained Block Transfer mechanism (CBLT) and the Multicast commands (MCST), see § 4 for the module's addressing and data transfer details.

N.B.: in the present manual the “generic” term “V1190” refers to all versions; “V1190 A” refers to both V1190 A and VX1190 A; “V1190 B” refers to both V1190 B and VX1190 B; except as otherwise specified.

1.2. Block Diagram

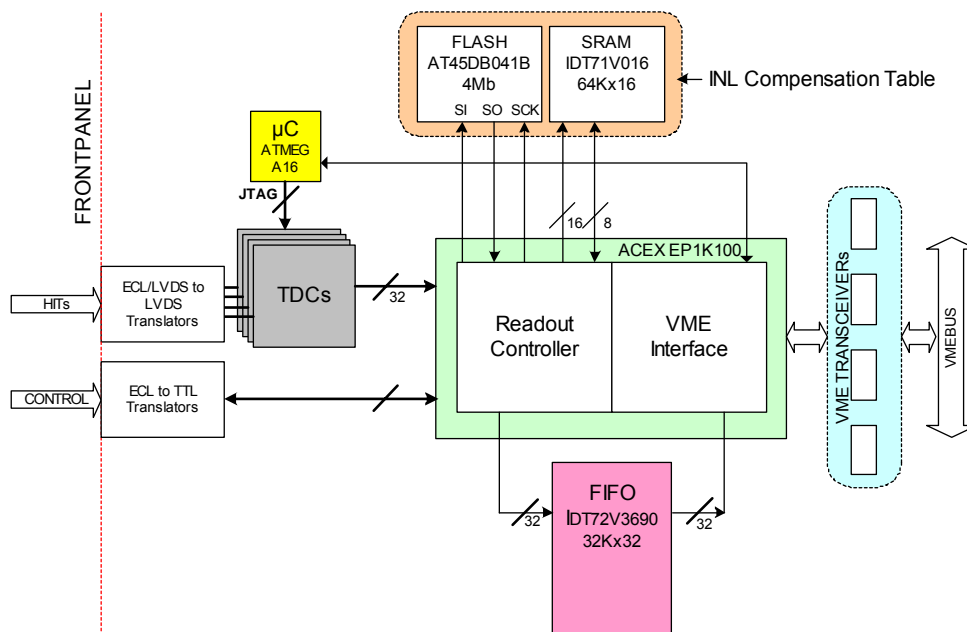

Fig. 1.1: Mod. V1190 A Block Diagram

The function of each block will be explained in detail in the following sections.

2. Functional description

2.1. HPTDC overview

The modules are based on High Performance TDC chips, developed by CERN/ECP-MIC Division [4].

In order to achieve a better use of the module, an overview of the TDC chips operation will be shown in the following sections.

2.1.1. TDC chips architecture

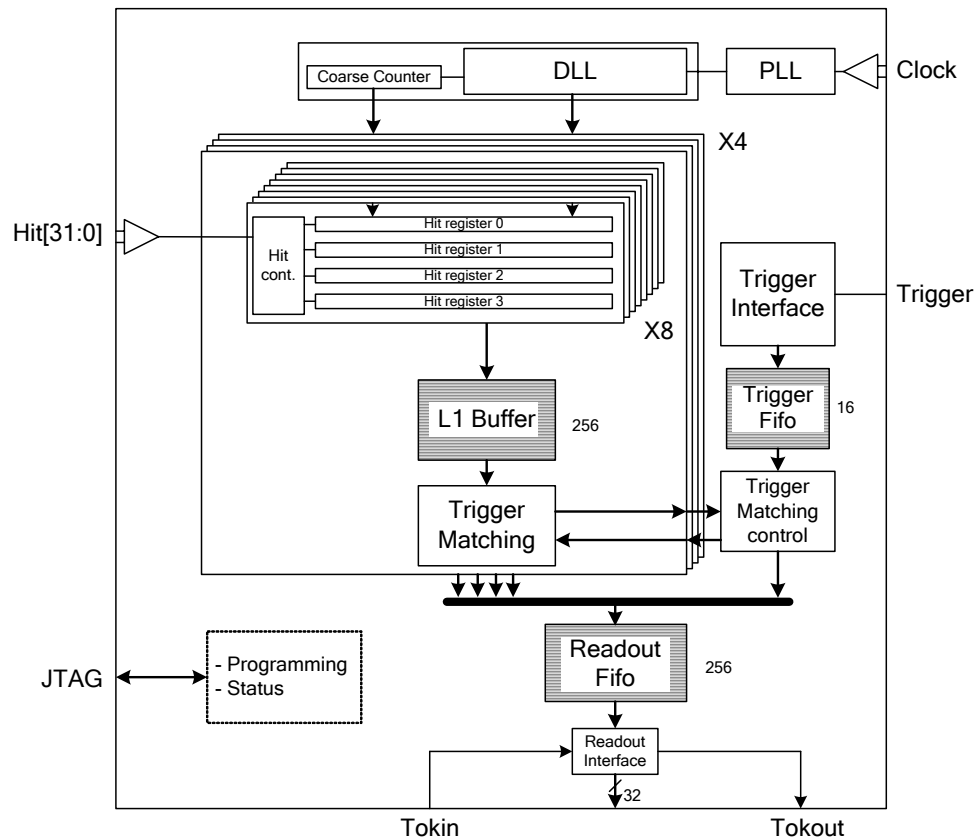

Fig. 2.1: TDC Simplified Block Diagram

The time base for the TDC measurements is a Delay Locked Loop (DLL) with 32 delay elements and a clock synchronous counter (coarse counter), both driven from the same clock reference. The clock reference can be taken directly from the clock input of the TDC chip (40 MHz) or can come from an on-chip PLL; the PLL can be used as a filter to remove jitter on the input clock (40 MHz) or can perform clock multiplication (160/320 MHz) to increase time resolution:

40 MHz (clock input or clock filtered) and DLL with 32 delay elements → 781 ps (800 ps)
 160 MHz and DLL with 32 delay elements → 195 ps (200 ps)
 320 MHz and DLL with 32 delay elements → 98 ps (100 ps)

A hit measurement is performed by storing the state of the DLL (fine/vernier counter) and the coarse counter in one hit register when a hit is detected. The TDC can be programmed to detect individual leading and/or trailing edges of the hit signal, or alternatively to perform a paired measurement consisting of one leading edge and the corresponding pulse width.

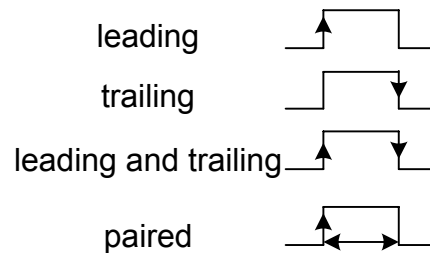

Fig. 2.2: Pulse detection

Each channel can store 4 hit measurements before being written into a 256 words deep buffer (L1 buffer) shared by a group of 8 channels.

The hit registers content is written into the L1 buffer together with a channel identifier. A 8 bit channel dependant offset programmable is added to the measurement before writing it into the L1 buffer.

If the channel buffer is full, when a new hit arrives, it will be ignored.

The two operation modes will be described in detail in the relevant sections; at this point we must remember that, when the module works in Continuous Storage mode (see § 2.3), measurements stored in the L1 buffer are passed directly to a common Readout FIFO.

When the module works in Trigger Matching mode (see § 2.4) a trigger matching function selects hits related to a trigger. The trigger information, consisting of a trigger time tag (bunch id) and an event id, are stored temporarily in a 16 words deep Trigger FIFO. A time window of programmable size is available for the trigger matching to accommodate the time spread of hits related to the same event.

The read-out FIFO is 256 words deep and its main function is to enable data to be read out while others are being processed. The effective size of the readout FIFO can be “artificially” reduced via the programming.

The TDCs feature several readout interfaces (parallel, serial, via Jtag, byte wise).

The V1190 features a parallel readout with the FPGA like read-out controller and all TDCs in the chain configured as slaves. The master sends the token (Token in Fig. 2.1) to the first slave chip in the chain which then starts to send its data. The read-out of individual words are controlled by a Data_ready / Get_data handshake. The token (Tokout in Fig. 2.1) is then passed on to the following slave TDCs in the chain until it finally arrives at the master.

In continuous storage a slave TDC can be programmed to keep token until no more data; otherwise the TDC passes the token; in trigger matching mode each slave must be programmed in order to keep the token until the end of the event.

It is possible to configure the programmable features in the TDC via JTAG, and also to get access to test facilities built into the TDC.

Programming of the device is separated into two scan path groups: setup scan path and control scan path.

The JTAG setup scan path is used to load programming data that can not be changed while the TDC is actively running. The JTAG setup scan path consists of a 646 bit configuration sequence plus one parity bit; refer to [4], page 32 for a detailed description.

The JTAG control scan path is used to enable/disable channels which can be done while the TDC is actively running. The JTAG control scan path is also used to initialize the PLL and DLL after power up: it consists of a 38 bit configuration sequence plus one parity bit; refer to [4], page 39 for a detailed description.

The setup/control scan paths have a parity bit which is continuously monitored for potential parity errors caused by single event upsets. Any detected parity error will set the respective error bit in the JTAG status register. Via JTAG it is possible to get access to the status of the TDC at any time. to monitor the TDC error status and all internal buffers occupancies (refer to [4], page 40).

On V1190 TDC programming and status monitoring is performed by an on board microcontroller (see § 5).

The HPTDC features 3 types of reset (refer to [4], page 16):

Event count reset: loads the programmed event count offset into the event id counter (useful in Trigger Matching mode only);

Bunch count reset: loads the programmed offsets into the coarse time counter, the trigger time tag (bunch id) counter and the reject counter; practically, it represents the T0 time reference.

Global reset: clears all buffers in the TDC, initialises all internal state machines and counters to their initial state and clears all detected error conditions.

See § 4.8 for details about the V1190 A/B reset logic.

2.2. Operating mode selection

Two different module setups are selectable via software for different acquisition scenarios, namely:

- Continuous Storage Mode
- Trigger Matching Mode

It is possible to switch from one operation setup to the other by simply reprogramming: the operating mode can be selected via the 00xx and 01xx OPCODES (see § 5.2).

N.B: with this operation the data in memory will be lost.

See § 6.2 for a full description of the data format.

2.3. Continuous Storage Mode

In this readout mode the data loaded into the L1 Buffer are straightly forwarded into the Readout FIFO of the TDC, where they are readout (by the FPGA master) and then loaded in the Output Buffer. All the hits received by the enabled channels are stored as valid data into the Output Buffer. The Time Origin (Time Zero) is represented by the latest RESET (see § 3.4.2).

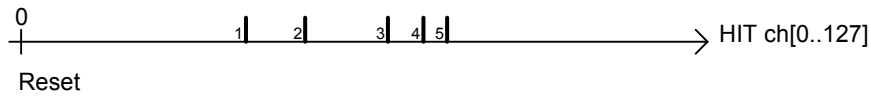

Fig. 2.3: Continuous storage

The storage of data in the Output Buffer never foresees the writing of the control words (HEADER and TRAILER). The data are written in sequential order², reflecting the time evolution of the external signals:

DATUM #1HIT time(1)
 DATUM #2HIT time(2)
 DATUM #3HIT time(3)
 DATUM #4HIT time(4)
 DATUM #5HIT time(5)
 DATUM #6HIT time(6)

If the total rate of HIT signals is higher than the transfer rate of the data from the TDCs to the Output Buffer (or from the Output Buffer to the VME) an overflow condition will be met:

OVERFLOW:
 Error word written into the FIFO
 Status register FULL bit set
 Trailer FULL bit = 1 into the Trailer

In this case there will be a data loss.

2.4. Trigger Matching Mode

Trigger matching is performed as a time match between a trigger time tag and the channel time measurements themselves. The trigger time tag is taken from the trigger FIFO and the time measurements are taken from the L1 buffer. Hits matching a trigger are passed to the common TDC readout FIFO.

A match between a trigger and a hit is detected within a programmable time window. The trigger matching control on the V1190 is handled through 4 programmable parameters³ (see § 5.3.1 and § 5.3.4):

- match window,
- window offset,
- extra search margin,
- reject margin.

² Hits closer than 100 ns might actually be misplaced.

³ The parameters programmable on the V1190 are functions of other 4 parameters which define the trigger matching function implemented in the HPTDC. The microcontroller translates the parameters set by the User on the V1190 into the parameters required by the chips.

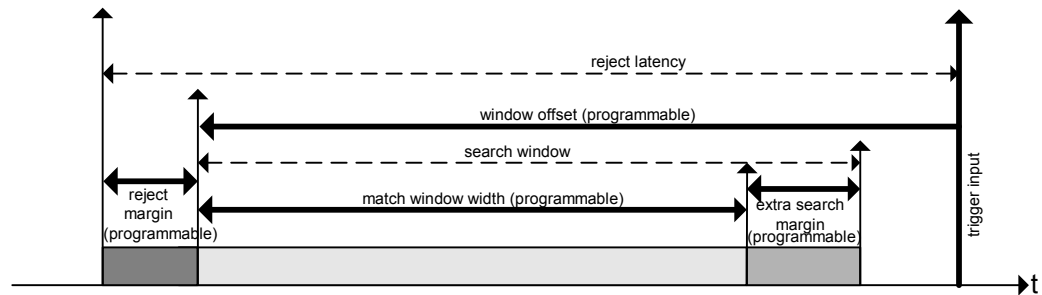

Fig. 2.4: Mod. V1190 A/B Trigger Matching Mode timing diagram

The trigger is defined as the bunch ID when the event of interest occurred. The trigger matching being based on the bunch ID means that the “resolution” of the trigger matching is one clock cycle (25 ns) and the configuration parameters of the trigger matching mode are also specified in steps of clock cycles.

The window offset is the temporal distance (with sign, see Fig. 2.6 and Fig. 2.7) between the trigger and the start of the trigger matching window. A specific requirement of the trigger matching function implemented in the HPTDC is that the trigger must be subsequent to the match window. This is required to insure that all hits matching a trigger are already in the L1 buffer when a trigger matching search is started.

On the V1190 it is possible also to program a match window straddling the trigger or subsequently to the trigger (see § 2.4.1): in this case because an artificial delay (40 clock cycle = 1 μ s) is induced on the trigger.

The search for hits matching a trigger is performed within an extended search window to guarantee that all matching hits are found even when the hits have not been written into the L1 buffer in strict temporal order. For normal applications it is sufficient to make the search window eight clock cycles larger than the match window (default setting for the V1190). The search window should be extended for applications where paired measurements of wide pulses are performed, as a paired measurement is not written into the L1 buffer before both leading and trailing edge have been digitized.

To prevent buffer overflows and to speed up the search time an automatic reject function reject older hits, when no triggers are waiting in the trigger FIFO. A separate reject counter runs with a programmable offset to detect hits to reject. The reject margin should be set to be at least 1 clock cycle to insure that no hits of interest are rejected.

In trigger matching mode all data belonging to an event are written into the common read-out FIFO between a TDC Header and a TDC Trailer. The TDC Header contains an event id and a bunch id (trigger time tag) and the TDC Trailer contains the same event id plus the event word count.

The stored data can represent an absolute time measurement (where time 0 is the latest Bunch reset) or optionally all time measurements read out are referenced to the start of match window (see § 5.3.5 and 5.3.6).

The trigger matching can be programmed to match a defined maximum number of hits to each trigger. The hits assigned to an event is in this case done on a “first come first served” basis. If the limiting function has rejected hits this will be signalled via an error marking word in the end of the event.

In case an error condition (L1 buffer overflow, Trigger FIFO overflow, memory parity error, limiting number of hits matched to event, etc.) has been detected during the trigger matching a special word with error flags is generated.

A unique feature of the trigger matching in the HPTDC is its capability to assign hit measurements to multiple triggers.

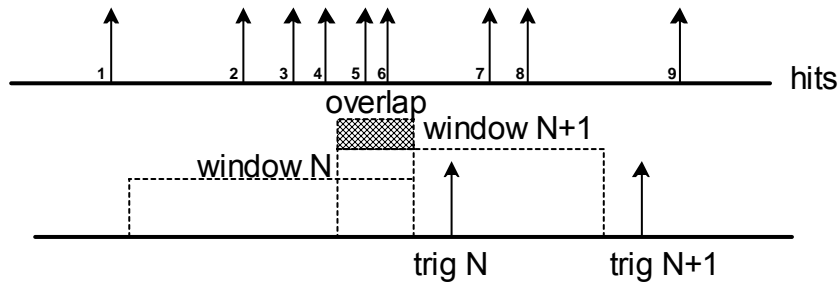

Fig. 2.5: Trigger matching windows overlap

If the Fig 2.5 shows hits received by one TDC, the events have the following structure:

TDC header, event id N, trigger time tag N (if enabled)
 DATUM Hit time 2
 DATUM Hit time 3
 DATUM Hit time 4
 DATUM Hit time 5
 DATUM Hit time 6
 TDC trailer, event id N, number data 5 (if enabled)

TDC header, event id N+1, trigger time tag N+1 (if enabled)
 DATUM Hit time 5
 DATUM Hit time 6
 DATUM Hit time 7
 DATUM Hit time 8
 TDC trailer, event id N+1, number data 4 (if enabled)

2.4.1. Timing constraints

The trigger matching related parameters must be programmed according to the following constraints.

1st case: the trigger matching window precedes the trigger arrival:

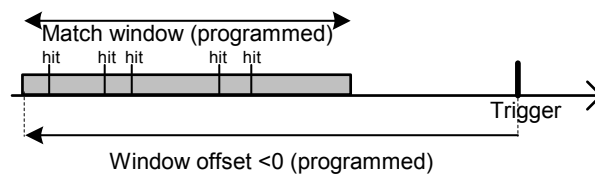

Fig. 2.6: Storage of hits occurred prior triggering

The window width and the window offset are encoded on 12 bit (25 ns LSB):

$$\text{Match window width} < |\text{window offset}| \leq 4095 \text{ clock cycle} = 102375 \text{ ns}$$

Note that in this case the window offset is negative.

2nd case: the trigger matching window is “straddling” the trigger or delayed with respect to the trigger:

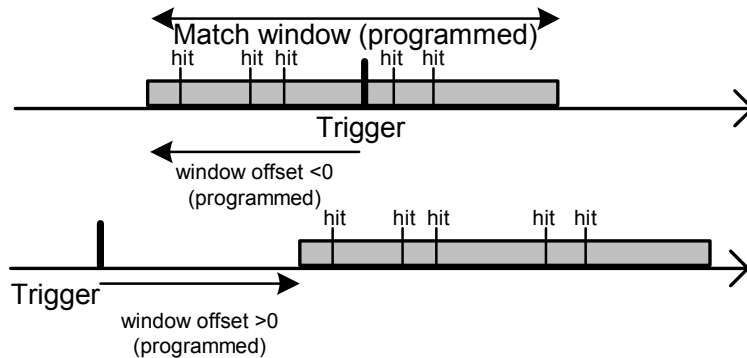

Fig. 2.7: Storage of hits which may occur after triggering

As previously described, the HPTDC does not allow to program a trigger matching window straddling the trigger or delayed with respect to the trigger; anyway this is allowed in the V1190, by providing a 1 μ s (40 clock cycles) delay on the trigger; the allowed trigger matching windows must thus agree with the following constraint:

$$\text{Match window width} + \text{window offset} \leq 40 \text{ clock cycles} = 1000 \text{ ns}$$

Note that in this case the Window offset can be either negative or positive, see Fig. 2.7.

2.5. Integral-non-linearity Compensation

The INL represents the error of the Input-Output characteristic $t-D$ of the TDC respect to the ideal one which is given by the following function:

$$D(t) = \text{int}(t / \text{LSB}) \quad \text{ideal characteristic}$$

Where D is the output data, t is the input time, LSB is the bin size (800, 200 or 100ps) and $\text{int}(x)$ represents the integer part of x .

NOTE: with analog circuit based TDCs, there is a variation of the LSB size due to the variation of gain and offset of the analog parts; in this case, the ideal input-output characteristic is given by the **best-fit line** calculated on the real input-output curve of the TDC (the best fit line is that one which minimizes the RMS error); the INL is then calculated as the difference between the curve and the best fit line. In the case of digital TDC (like the V1190), the gain and the offset come from a clock and it is very precise, so the ideal line can be calculated a priori without any interpolation (gain = 1/LSB, offset = 0). It must be noticed that the TDC chips feature an intrinsic INL, due to DNL, which has a 25 ns period (= TCLOCK).

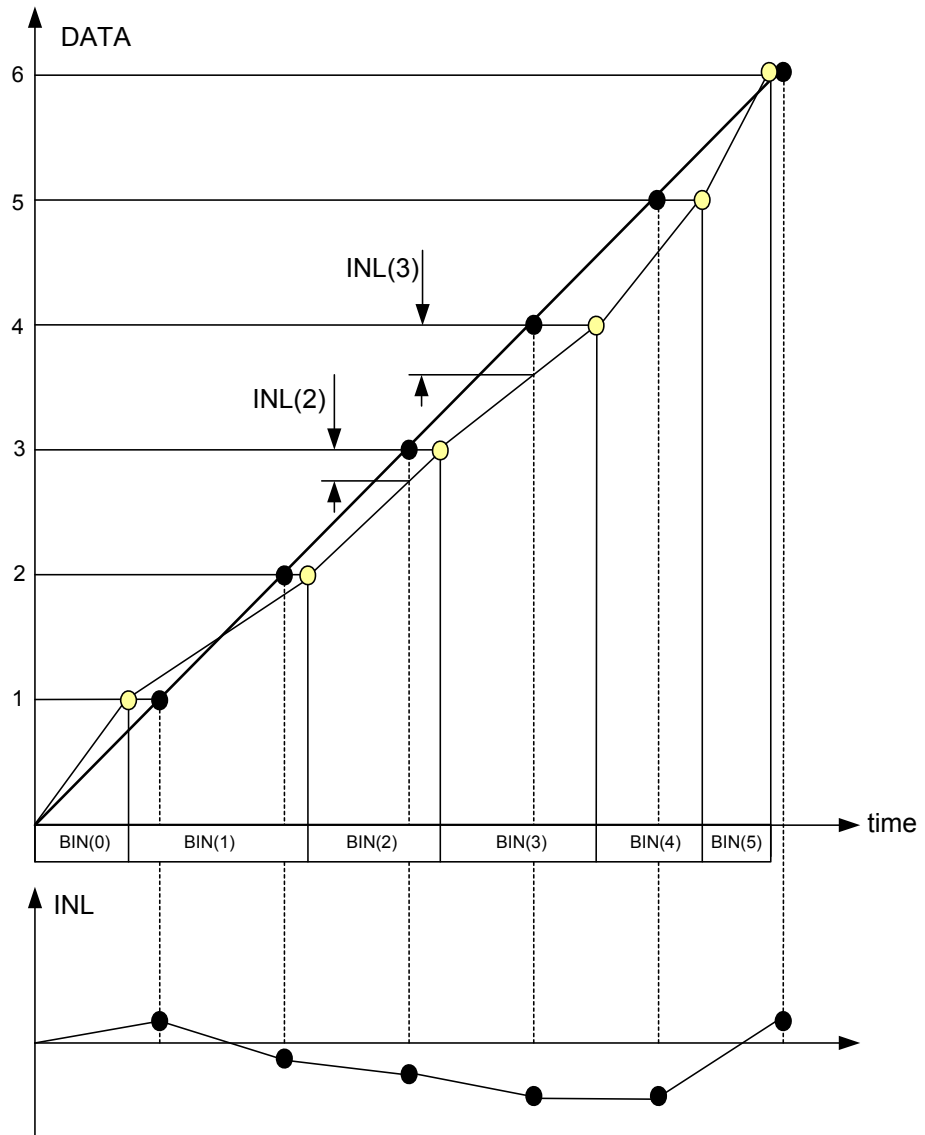

Fig. 2.8 INL I/O Characteristic

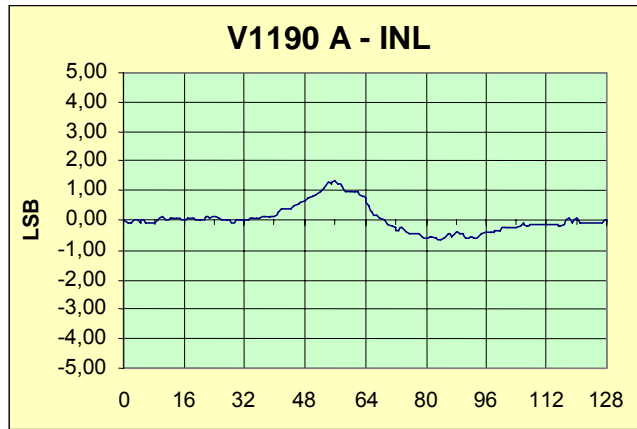

Fig. 2.9 INL trace @ 200ps

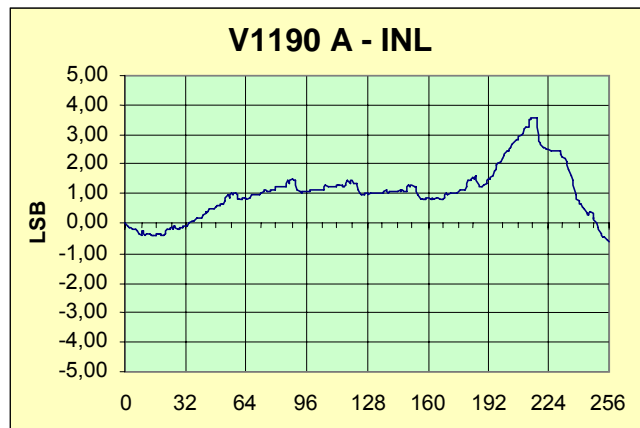

Fig. 2.10 INL trace @ 100ps

The INL curve can be corrected using a compensation look-up table: the curve is periodic so the LUT will cover only the BINs in a clock period (i.e. 256 entries when LSB=100 ps). A sample which falls in a certain BIN inside the clock period is corrected by the subtraction of the INL value for that BIN.

The INL compensation has been done only for 200 ps and 100 ps resolutions. For 800 ps the INL is good and there isn't any advantage in compensating it.

LSB = 200 ps:

$LUT[n] = \text{round}(INL[n]) \quad n=[0:127]$
 $D' = D - LUT[D \& 0x7F]$

LSB = 100 ps:

$LUT[n] = \text{round}(INL[n]) \quad n=[0:255]$
 $D' = D - LUT[D \& 0xFF]$

NOTE: after the compensation, some **missing codes** can appear on the histogram; in fact, all the BINs are "scrambled" by the LUT and it is possible that BIN[x] is moved into BIN[y] but no BIN[z] is moved into BIN[x] which remains empty.

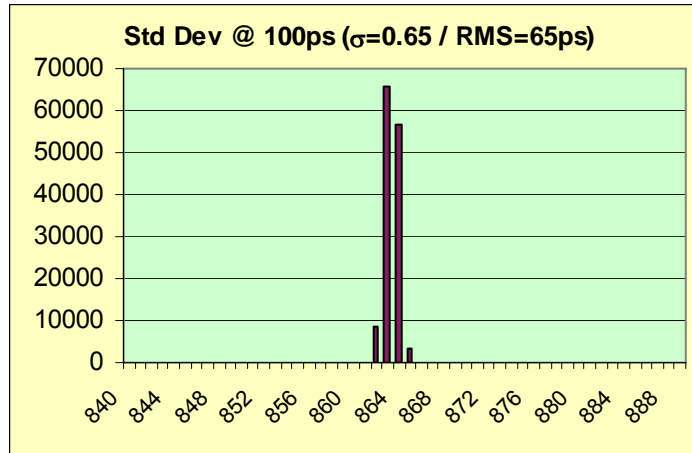

Fig. 2.11 RMS example @ 100ps (T4=85ns) after INL compensation

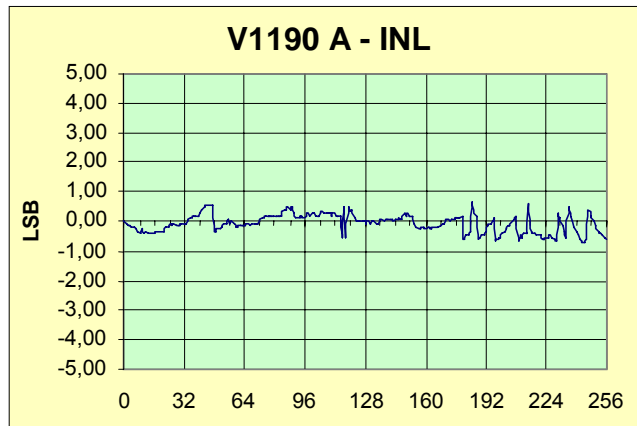

Fig. 2.12 INL for 100 ps after INL compensation

The Lock-Up table was calculated and loaded into the Flash Memory (see Appendix A). The INL compensation can be disabled by setting to 0 the compensation enable bit (bit 5) in the Control Register (default setting: compensation enabled, see § 6.3).

3. Technical specifications

3.1. Packaging

The modules are housed in a 6U-high, 1U-wide VME unit. The boards host the VME P1, and P2 connectors and fit into both VME standard and V430 backplanes.

3.2. Power requirements

The power requirements of the modules' versions are as follows:

Table 3.1: Model V1190 A/B power requirements

Power supply	Mod. V1190 A	Mod. V1190 B
+5 V	5.50 A	2.90 A

3.3. Front Panel

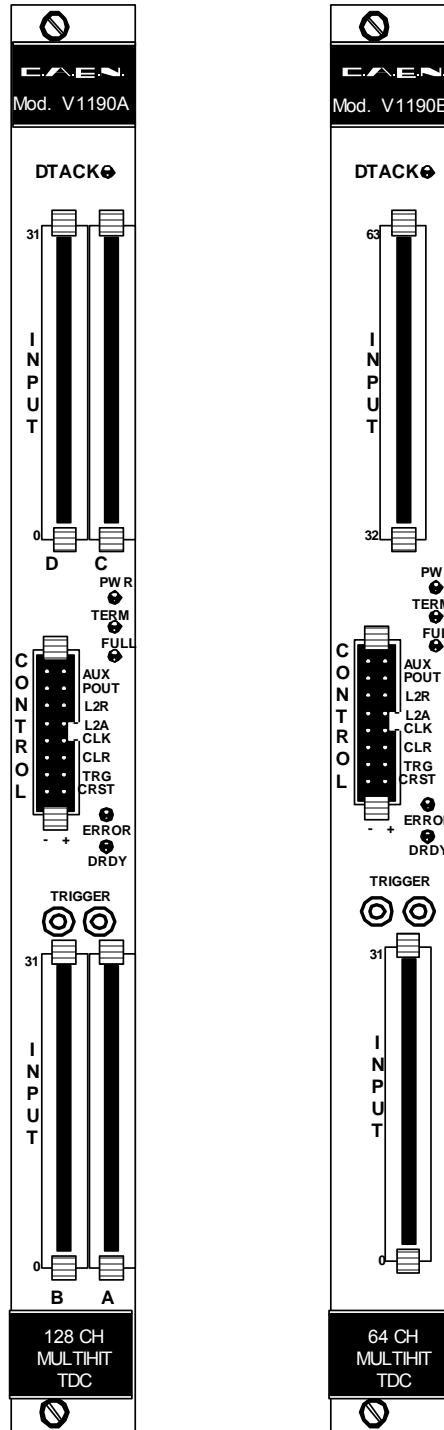

Fig. 3.1: Model V1190 A/V1190 B front panels

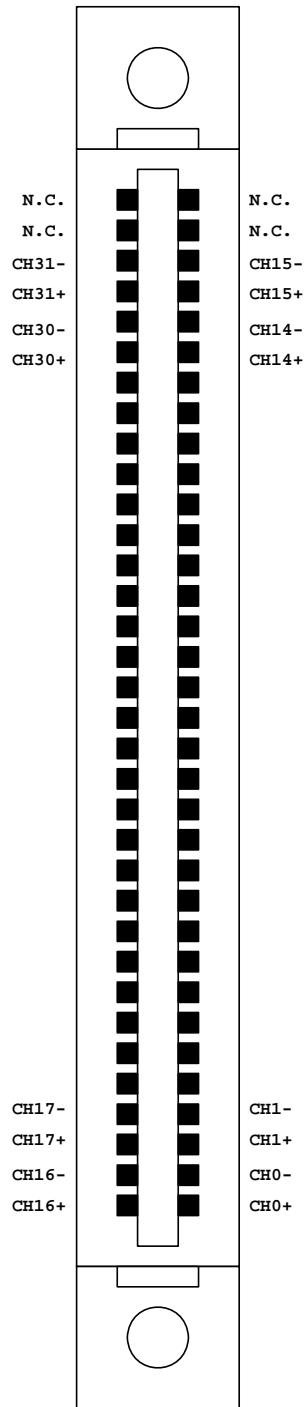

Fig. 3.2: INPUT connector pin assignment

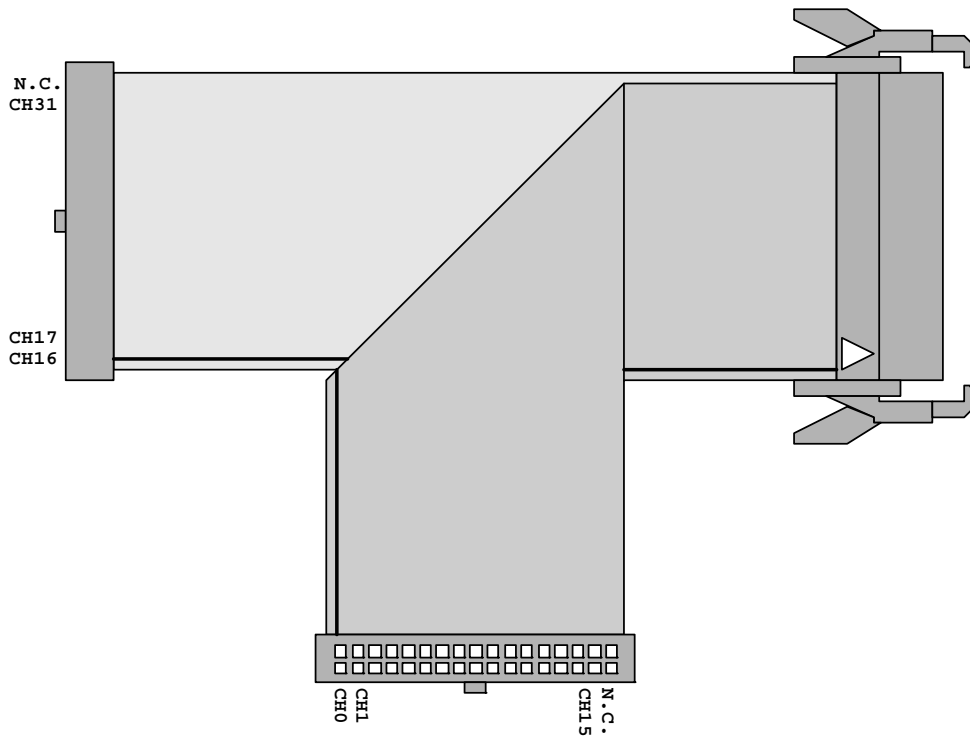

Fig. 3.3: INPUT connector cabling (Mod. A967 Cable Adapter)

3.4. External connectors

The location of the connectors is shown in Fig. 3.1. Their function and electro-mechanical specifications are listed in the following subsections.

3.4.1. INPUT connectors

Mechanical specifications (Mod. V1190 A):

N. 4 High Density connectors⁴, Robinson Nugent P50E-068-P1-SR1-TG type, (34+34) pins; for the 128 single channel inputs.

Connector A refers to Channels 0 to 31.

Connector B refers to Channels 32 to 63.

Connector C refers to Channels 64 to 95.

Connector D refers to Channels 96 to 127.

Electrical specifications:

ECL/LVDS input signals, 110 Ω impedance. The 17th higher pair of pins of each connector's side is not connected.

⁴ The CAEN Mod. A967 cable adapter, which allows to adapt one High Density connector into two 1" 17+17-pin Header-type connectors, is available. Mod. V1190 B has Connector 0÷31 and 32÷63 (64 ch).

3.4.2. CONTROL connector

Mechanical specifications:

two 8+8-pin, 3M 3408-5202 Header-type connectors.

- AUX: not used.
- OUT_PROG: differential ECL level, 110 Ω impedance.
- L2_REJECT: not used.
- L2_ACCEPT: not used.
- CLOCK: Rising-edge active, differential ECL level, 110 Ω; 40 MHz max freq.
- CLR: Active high, differential ECL level, 110 Ω impedance; min. width 25 ns.
- TRIGGER: Rising-edge active, differential ECL level, 110 Ω; min. width 25 ns, double Trigger resolution: 75 ns.
- CRST: Rising-edge active, differential ECL level, 110 Ω; min. width 25 ns.

Pin assignment is shown in Fig. 3.4.

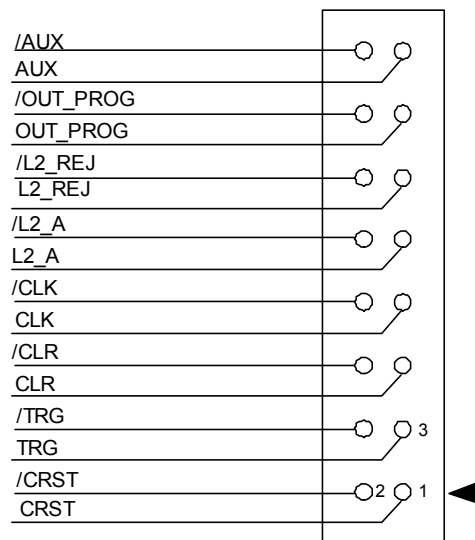

Fig. 3.4: CONTROL connector pin assignment

3.4.3. EXTERNAL TRIGGER connectors

Mechanical specifications:

two 00-type LEMO connectors (bridged).

Electrical specifications:

Rising-edge active, NIM, high impedance; min. width 25 ns, double Trigger resolution: 75 ns

If this input is used, a 50 Ohm termination is required; in daisy chain configuration, the termination must be inserted on the last board in the chain.

This signal is internally or-wired with the TRG signal on the Control Connector (see §3.4.2)

3.5. Other front panel components

3.5.1. Displays

The front panel (refer to Fig. 3.1) hosts the following LEDs:

DTACK:	<i>Colour:</i> green. <i>Function:</i> it lights up green whenever a VME read/write access to the board is performed.
PWR:	<i>Colour:</i> green/red. <i>Function:</i> it lights up green when the board is inserted into the crate and the crate is powered up; when it is red, it indicates that there is an over-current status: in this case, remove the overload source, switch the module off and then switch it on again.
TERM:	<i>Colour:</i> green. <i>Function:</i> it lights up green when the lines of the control bus are terminated.
FULL:	<i>Colour:</i> red. <i>Function:</i> it lights up when the Output Buffer is full.
ERROR:	<i>Colour:</i> red. <i>Function:</i> it lights up to signal a TDC global error
DRDY:	<i>Colour:</i> yellow. <i>Function:</i> it lights up when at least one event/data (depending on acquisition mode, see § 6.4) is present in the Output Buffer.

N.B.: FULL, ERROR and DRDY LEDs light up for a while at power ON to indicate that the board is configuring.

3.6. Internal hardware components

The V1190 A module is constituted by a motherboard with 2 piggy-back boards plugged into it. The V1190 B has no piggy-back board. In the following some hardware setting components, located on the boards, are listed. See Fig. 3.5 for their exact location on the PCB and their settings.

3.6.1. Switches

ROTARY SWITCHES:	<i>Type:</i> 4 rotary switches. <i>Function:</i> they allow to select the VME address of the module. See Fig. 3.5 for their location.
SW1:	<i>Type:</i> DIP switch.

SW2:

Function: it allows to switch from/to internal/external clock

Right position (dot visible): external clock;

Left position (dot not visible): internal clock.

Type: DIP switch.

Function: it allows the hardware termination (if enabled) of the Control Bus on 110 Ω (see also § 6.3)

Low position (dot visible): Control Bus not terminated;

High position (dot not visible): Control Bus terminated.

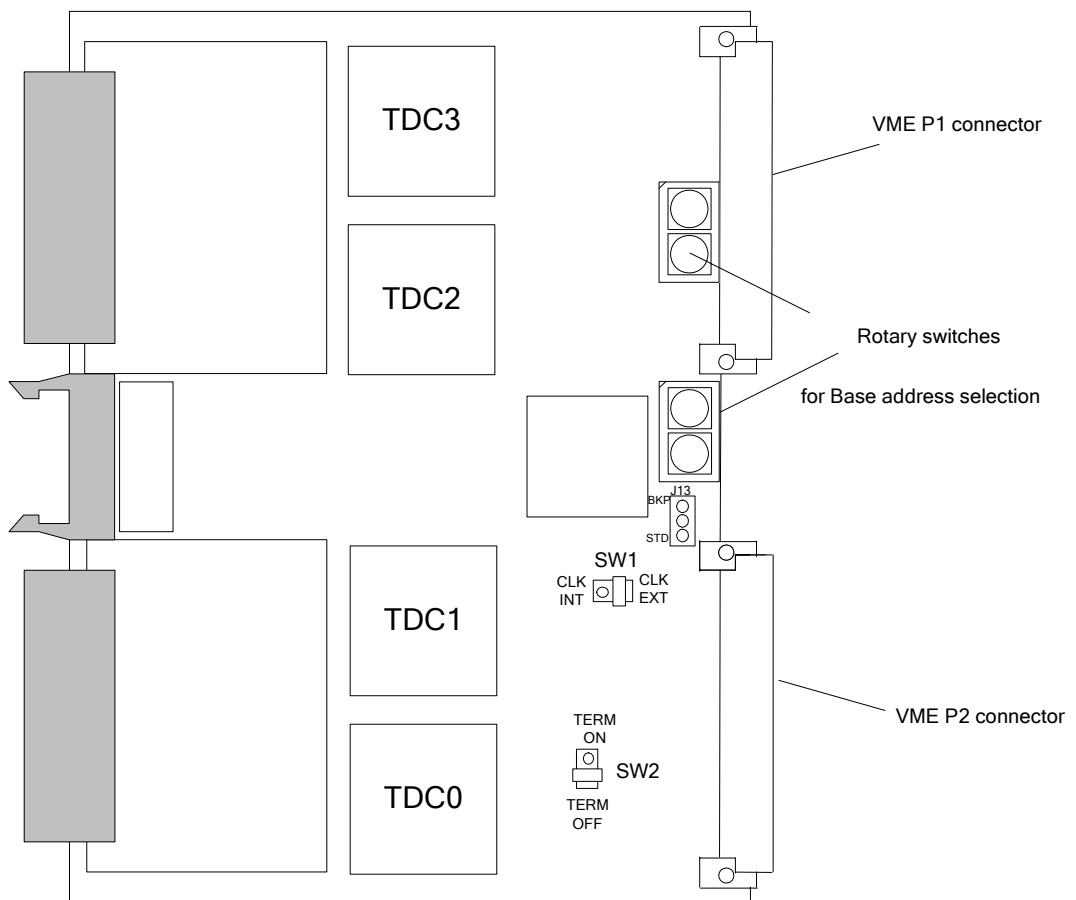

Fig. 3.5: Component Location (V1190 A⁵)

⁵ Mod. V1190 B has two TDC chips only

3.7. Technical specifications table

Table 3.2 : Model V1190 A/B technical specifications

Packaging	6U-high, 1U-wide VME unit
Power requirements	Refer to Table 3.1
Inputs	V1190 A/B: 128/64 ECL and LVDS inputs, 110 Ω impedance
Double hit resolution	5 ns
Acquisition modes	Trigger Matching Mode; Continuous Storage Mode
Match window	Programmable (see § 5.3)
Built-in memory	32 kwords deep Output Buffer
LSB	VME programmable: 100 / 200 / 800 ps
Dynamic Range	104 μ s (200 ps and 800 ps LSB); 52 μ s (100 ps LSB)
RMS resolution (with compensation⁶ enabled)	<320 ps @ 800 ps res. <140 ps @ 200 ps res. <80 ps @ 100 ps res.
Integral non linearity (with compensation⁶ enabled)	<0.3 LSB @ 800 ps res. <1 LSB @ 200 ps res. <1 LSB @ 100 ps res.
Max. differential non linearity (with compensation⁶ disabled)	<0.2 LSB @ 800 ps res. <0.3 LSB @ 200 ps res. <0.5 LSB @ 100 ps res.
Interchannel Isolation	\leq 0.7 LSB
Offset spread	<2 ns ⁷
EXT TRIGGER input	Two LEMO 00 bridged connectors, NIM signal, 50 Ω
Double Trigger resolution	75 ns
Clock source	Internal (40 MHz) or External (on <i>Control</i> connector), dip switch selectable
Control inputs	<u>active-high, differential ECL input signals:</u> CLR: performs the Hardware CLEAR (min. width: 25 ns), see § 4.8.1 <u>rising-edge active, differential ECL input signals:</u> CRST: performs the Bunch RESET (min. width: 25 ns), see § 4.8.5 CLK: external clock (max. freq.: 40 MHz) TRG: trigger for the TDC latching (min. width: 25 ns) L2_A; L2_REJ.
Control outputs	<u>differential ECL output signal:</u> OUT_PROG: control output signal, programmable via the <i>out prog control</i> register (see § 6.23)
Displays	DTACK: green LED; lights up at each VME access. PWR: green/red LED; green: power ON, red: failure status. TERM: green LED; control bus termination ON. FULL: red LED; memory full. ERROR: red LED; TDC global error. DRDY: yellow LED; at least one datum/event in the Output Buffer
VME	<i>Addressing modes:</i> A24, A32, MCST <i>Data transfer modes:</i> D16, D32, MBLT32, BLT64, CBLT32, CBLT64 <i>Readout rate:</i> 33 Mbyte/s

⁶ See § 2.5

⁷ It can be compensated via Offset Adjust, see § 5.7

4. Operating modes

4.1. Installation

The Mod. V1190 A/B boards fit into both V430 VME 6U (JAUX dataway) and standard 6U VME crates. The boards support live insertion/extraction into/from the crate, i.e. it is possible to insert or extract them from the crate without turning the crate off.

CAUTION: all cables connected to the front panel of the board must be removed before extracting/inserting the board from/into the crate.



CAUTION

**ALL CABLES MUST BE REMOVED FROM THE FRONT PANEL
BEFORE EXTRACTING THE BOARD FROM THE CRATE!**

4.2. Power ON sequence

To power ON the board follow this procedure:

1. insert the V1190 A/B board into the crate: as the board is inserted, the PWR green LED (see § 3.5.1) lights up indicating that the board is powered;
2. after insertion, the TERM LED lights up green (if the TERM switch is ON), the FULL LED and the ERROR LED become red and the DRDY LED becomes yellow; this indicates that the board is turned on and is configuring;
3. after a few seconds, the FULL, the ERROR and the DRDY LEDs will light off: this indicates that the board is ready to acquire data.

N.B.: if the PWR LED becomes red instead of being green, there is an overload and the over-current protection is now running. In order to acquire data, it is necessary to remove the overload source, then turn the board off and switch it on again. Sometimes, it may happen that the PWR LED is red as soon as the board is inserted in the crate: this is due to the fact that the board has been just misplaced into the crate. In this case, extract the board and insert it again into the crate.

4.3. Power ON status

At power ON the module is in the following status:

- the Output Buffer is cleared;
- registers are set to their default configuration (see § 5 and § 6);
- the TDCs are in the following status (see also § 5):

trigger matching	disabled
matching window width	500 ns (0x14)
matching window offset	-1 μ s (0xFFD8)
extra search window	200 ns (0x8)
reject margin	100 ns (0x4)
keep token	set
subtraction trigger time	disabled
global offset	0
channel offset	0 (all channel)
edge detection	leading
trailing/leading resolution	100 ps
width pair mode resolution	100 ps
TDC header/Trailer	enabled
error mark	enabled
error bypass	disabled
error type	all enabled
dead time between hits	5 ns
TDC readout FIFO size	256
max number of hits per event	no limit
channels	all enabled

At power ON or after a hardware reset the module must thus be set to the desired configuration.

4.4. Addressing capability

The module can be addressed in 2 different ways, specifically:

1. via Base Address;
2. via Multicast/Chained Block Transfer addressing mode.

4.4.1. Addressing via Base Address

The module works in A24/A32 mode. This implies that the module's address must be specified in a word of 24 or 32 bit. The Address Modifier codes recognised by the module are summarised in Table 4.1.

Table 4.1: Module recognised Address Modifier

A.M.	Description
0x3F	A24 supervisory block transfer
0x3E	A24 supervisory program access
0x3D	A24 supervisory data access
0x3C	A24 supervisory 64 bit block transfer
0x3B	A24 non privileged block transfer
0x3A	A24 non privileged program access
0x39	A24 non privileged User data access
0x38	A24 non privileged 64 bit block transfer
0x0F	A32 supervisory block transfer
0x0E	A32 supervisory program access
0x0D	A32 supervisory data access
0x0C	A32 supervisory 64 bit block transfer)
0x0B	A32 non privileged block transfer
0x0A	A32 non privileged program access
0x09	A32 non privileged data access
0x08	A32 non privileged 64 bit block transfer

The Base Address can be selected in the range:

0x000000 ←→ 0xFF0000 A24 mode
0x00000000 ←→ 0xFFFF0000 A32 mode

The Base Address of the module can be fixed through four rotary switches, housed on two piggy-back boards plugged into the main printed circuit board (see § 3.6.1)

4.4.2. Base addressing examples

The following is an example of Base Addressing for two boards inserted in a VME crate.

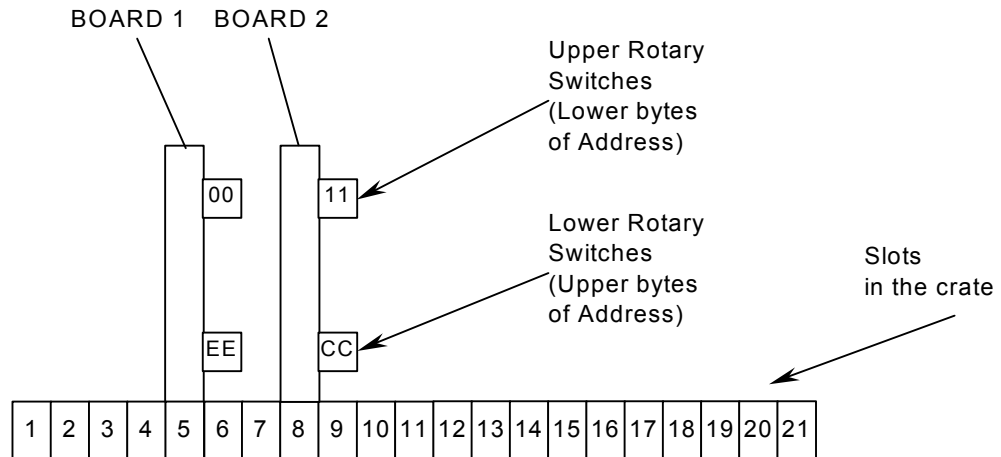

Fig. 4.1: Base Addressing: Example 1

If the board 1 and board 2 are respectively with the rotary switches for VME Base Addressing set as shown in the figure, the complete address of the registers of the two boards will be as follows:

Board 1:

Base addressing A32: 0xEE000000 + offset
Base addressing A24: 0x000000 + offset

Board 2:

Base addressing A32: 0xCC110000 + offset
Base addressing A24: 0x110000 + offset

4.4.3. MCST/CBLT addressing

When the Multicast/Chained Block Transfer addressing mode is adopted, the module works in A32 mode only. The Address Modifiers codes recognised by the module are:

- MCST:** 0x0E A32 supervisory block transfer
- 0x0D A32 supervisory 64 bit block transfer
- 0x0A A32 non privileged block transfer
- 0x09 A32 non privileged 64 bit block transfer
- CBLT:** 0x0F A32 supervisory block transfer
- 0x0C A32 supervisory 64 bit block transfer
- 0x0B A32 non privileged block transfer
- 0x08 A32 non privileged 64 bit block transfer

The boards can be accessed in Multicast Commands mode (MCST mode, see [2]), that allows to write in the registers of several boards at the same time by accessing the MCST Base Address in A32 only once.

The boards can be accessed in Chained Block Transfer mode (CBLT mode, see [2]) that allows to readout sequentially a certain number of contiguous boards in a VME crate. This access is allowed in BLT32 and BLT64 modes only to the MCST Base Address.

N.B.: The Base Address used for MCST and CBLT operations is the same, i.e. throughout this User's Manual the "MCST Base Address" identifies the same Address, used both for MCST commands (in Write only, for the allowed registers) and the CBLT Readout (in Read only, for the Output Buffer only).

The MCST Base Address must be set in a different way from the ordinary Base Address. Its most significant byte (i.e. bits 31 through 24 of base address) must be written in the MCST/CBLT Address Register (see § 6.11) and must be set in common to all boards belonging to the MCST/CBLT chain (i.e. all boards must have the same setting of the MCST/CBLT Base Address on bits 31 through 24). The default setting is 0xAA.

In CBLT/ MCST operations, the IACKIN/ IACKOUT daisy chain is used to pass a token from one board to the following one. The board which has received the token stores/sends the data from/to the master via MCST / CBLT access. No empty slots must thus be left between the boards or, in alternative, empty slots can be left only in case VME crates with automatic IACKIN/IACKOUT short-circuiting are used.

Once the addresses have been set, the first and last board in a chain must have, respectively, only the FIRST_BOARD (F_B) and only the LAST_BOARD (L_B) bit set to 1 in the MCST Control Register (see § 6.12). On the contrary, all intermediate boards must have both the FIRST_BOARD and the LAST_BOARD bits set to 1 (active, intermediate) or both the FIRST_BOARD and the LAST_BOARD bits set to 0 (inactive). By default these bits are set to 0 (the board is inactive).

Board status	Board position in the chain	F_B bit	L_B bit
inactive	-	0	0
active	last	0	1
active	first	1	0
active	intermediate	1	1

Please note that in a chain there must be one (and only one) *first board* (i.e. a board with F_B bit set to 1 and the L_B bit set to 0) and one (and only one) *last board* (i.e. a board with F_B bit set to 0 and the L_B bit set to 1).

The complete address in A32 mode is:

A [31:24] MCST/CBLT Address
A [23:16] 00
A [15:0] offset

In MCST/CBLT operation it is possible to define more chains in the same crate, but each chain must have an address different from the other.

N.B.: In CBLT operation the data coming from different boards are tagged with the HEADER and with the TRAILER words containing the GEO address in the 5 MSB (see § 4.4.2). It is up to the User to write the GEO address in the GEO register before executing the CBLT operation, since the V1190 A/B are not enabled to pick the GEO address from the VME Bus. If the GEO address is not written in the relevant register before performing the CBLT operation, it will not be possible to identify the module which the data are coming from.

4.4.4. MCST/CBLT addressing examples

The following is an example of MCST and CBLT addressing for four V1190 A/B boards plugged into a VME crate. To access the boards the steps to be performed are as follows:

1. Set the MCST address (see § 6.11) for all boards via VME Base Address;
2. Set the bits F_B and L_B of the MCST Control Register (see § 6.12) according to the operational status (active or inactive) of each board and to its position in the chain (first, intermediate or last);
3. Write or read the boards via MCST/CBLT addressing.

An example of User procedures which can be used to perform a write access is:

vme_write (address, data, addr_mode, data_mode)

which contain the following parameters:

Address:	the complete address, i.e. Base Address + offset;
Data:	the data to be either written;
Addr_mode:	the addressing mode (only A32 allowed in MCST);
Data_mode:	the data mode.

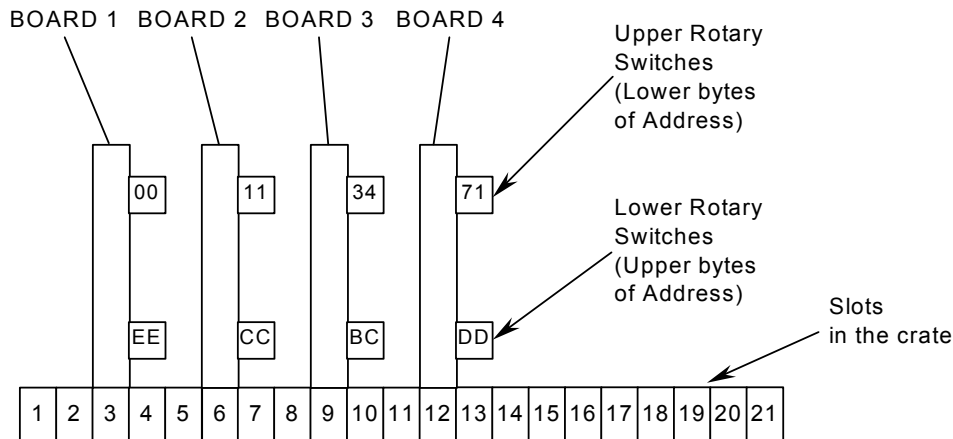

Fig. 4.2: MCST/CBLT Addressing Example

In the following, a software example, using the above mentioned procedures, is listed:

Example of Access via Base Address

```
vme_write (0xEE001010, 0xAA, A32, D16) /* set MCST Address=0xAA for board 1 */
vme_write (0xCC111010, 0xAA, A32, D16) /* set MCST Address=0xAA for board 2 */
vme_write (0xBC341010, 0xAA, A32, D16) /* set MCST Address=0xAA for board 3 */
vme_write (0xDD711010, 0xAA, A32, D16) /* set MCST Address=0xAA for board 4 */
vme_write (0xEE001012, 0x02, A32, D16) /* set board 1 = First */
vme_write (0xCC111012, 0x03, A32, D16) /* set board 2 = Active */
vme_write (0xBC341012, 0x00, A32, D16) /* set board 3 = Inactive */
vme_write (0xDD711012, 0x01, A32, D16) /* set board 4 = Last */
vme_write (0xAA001014, 0x00, A32, D16) /* send SOFTWARE RESET to all the boards */
```

N.B.: there must be always one (and only one) FIRST BOARD and one (and only one) LAST BOARD.

4.5. Interrupter capability

The Mod. V1190 A/B house a VME INTERRUPTER. The modules respond to D16 Interrupt Acknowledge cycles providing: a word whose 8 LSB are the STATUS/ID.

4.5.1. *Interrupt Status/ID*

The interrupt STATUS/ID is 8-bit wide, and it is contained in the 8 LSB of the Interrupt Vector Register (see § 6.9). The register is available at the VME address: Base Address + 0x100C.

4.5.2. *Interrupt Level*

The module's interrupter produces its request on one of the 7 IRQ lines. The interrupt level is programmable via VME (see § 6.8).

4.5.3. *Interrupt Generation*

An Interrupt is generated when the number of words stored in the memory equals the value written in the Almost Full Level Register at the VME address: Base Address + 0x1022 (see § 6.19). If the value in Interrupt Level Register is set to 0 the interrupt is disabled (default setting).

4.5.4. *Interrupt Request Release*

The INTERRUPTER removes its Interrupt request when either a Read Access is performed to the Output Buffer so that the number of events stored in the memory decreases and becomes less than the value written in the Almost Full Level Register or when a module's clear is performed.

4.6. Trigger Matching Mode data transfer

The Output Buffer can be readout via VME through D32, BLT32, BLT64, CBLT32 and CBLT64 modes. The module has to be programmed in order to work in the required mode (see § 5.2.1), and some parameters have to be set in order to keep data aligned (i.e. to transfer an integer number of events per cycle). In the following each readout mode will be described in detail.

Nw is the number of words which compose an event (note that such number is not constant but changes from event to event). **It's up to the user to verify the presence of valid data in the Output Buffer before read out**; this can be performed via the Status Register read out (*Data Ready Bit*, see § 6.4). When a trigger signal occurs, an event is loaded into the Output Buffer (see § 6.2). The DATA_READY bit in the Status Register is set to one when at least one event is present in the buffer.

4.6.1. D32 OUTPUT BUFFER readout (Trigger Matching)

This readout mode can be performed in two ways:

- Wait for DATA_READY bit to be set, then readout the **Nw** words until the *global Trailer* (TRAILER).
- Start readout without waiting for DATA_READY: if BERR is disabled, *fillers* will be readout until a *global header* is met (otherwise, if BERR is enabled, BERR is signalled and no filler is transferred); then **Nw** words will be transferred until a global TRAILER is readout.

4.6.2. BLT32/64 OUTPUT BUFFER readout with Bus Error and Event Aligned BLT disabled

BLT32/64 readout with BERR and Event Aligned BLT mode disabled does not permit to collect one or more complete events since the number of bytes **Nb** which are transferred in a BLT cycle has usually a "typical" value (256, 2048...) which rarely coincide with a multiple of the number of bytes **NB** composing an event, i.e. $NB = Nw \cdot 4$ (note that **Nw** is not constant but changes from event to event). It is more than likely that in a BLT cycle an event could be partially read out and the remaining part would be read out in the subsequent cycle. If the Output Buffer contains a number **N** of words smaller than $Nb/4$ (the number of words readout in one BLT cycle), the module transfers its memory content, completed with $(Nb/4) - N$ *fillers*.

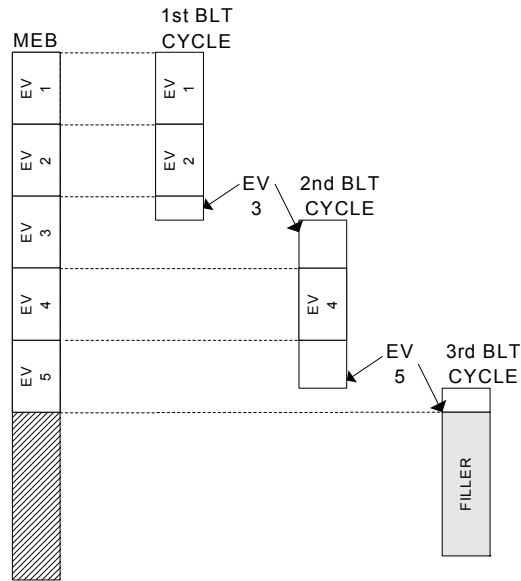

Fig. 4.3 Example of BLT data transfer with BERR and Event Aligned BLT disabled

4.6.3. **BLT32/64 OUTPUT BUFFER readout with Bus Error enabled**

In this mode the module produces a BERR signal (see § 6.3) once the last data in the Output Buffer has been transferred and no filler is added.

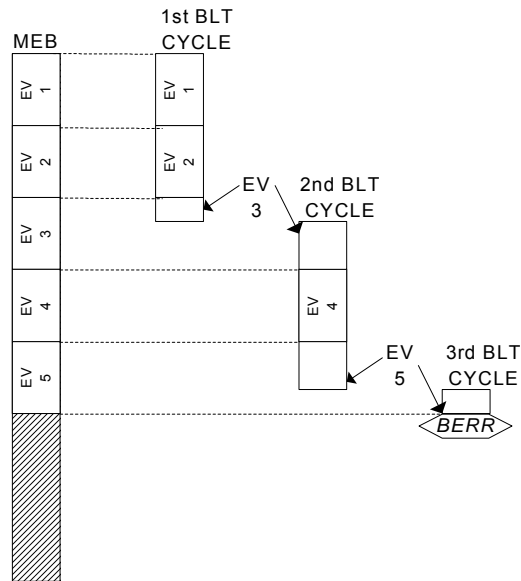

Fig. 4.4 Example of BLT data cycle with BERR enabled and Event Aligned BLT disabled

4.6.4. **BLT32/64 OUTPUT BUFFER readout with Event Aligned BLT enabled**

This mode allows to transfer an integer number **Ne** of events (in fig. 4.5 $N_e = 2$), set via the BLT Event Number Register (see § 6.20). The default setting value of this register is 0, so this mode disabled. In order to enable the Event Aligned BLT the desired number of events N_e must be written in the BLT event number register. This mode allows the module to transfer a maximum number N_e of events; three cases may occur:

- The memory has a number of events smaller than N_e : the module transfers its memory content (with one or more BLT cycles) and completes the cycle adding fillers (see § 6.2.3).
- The memory has a number of events larger than N_e and $N_b/4 > \sum N_w$ ⁸ (where $N_b/4$ is the number of words transferred in one BLT cycle): the module transfers N_e events per cycle and eventually completes the cycle adding fillers.
- The memory has a number of events larger than N_e and $N_b/4 < \sum N_w$: the transfer requires more than one cycle to be completed, the last cycle eventually is completed with fillers.

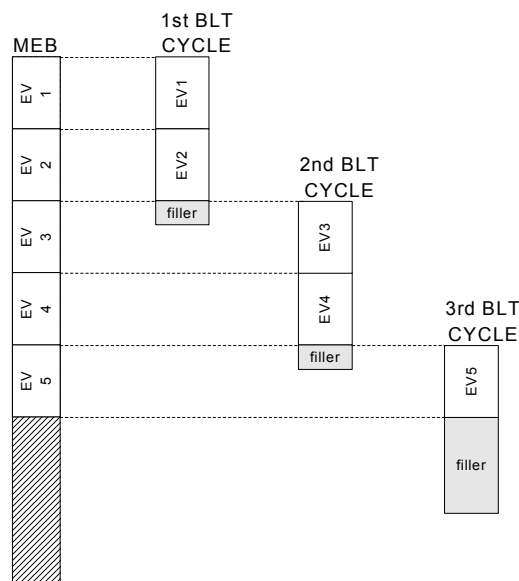

Fig. 4.5 Example of BLT data cycle with BERR disabled and Event Aligned BLT enabled

⁸ $\sum N_w$ = total number of words

4.6.5. **BLT32/64 OUTPUT BUFFER readout with both Event Aligned BLT and Bus Error enabled**

This mode allows the module to transfer a maximum number N_e of events; three cases may occur:

- The memory has a number of events smaller than N_e : the module transfers its memory content (with one or more BLT cycles) then asserts BERR, thus terminating the cycle.
- The memory has a number of events larger than N_e and $N_b/4 > \sum N_w$: the module transfers N_e events in one cycle, then asserts BERR thus terminating the cycle.
- The memory has a number of events larger than N_e and $N_b/4 < \sum N_w$: the transfer requires more than one cycle to be completed.

N.B.: Enabling the BERR is useful in order to save time, avoiding fillers' transfer.

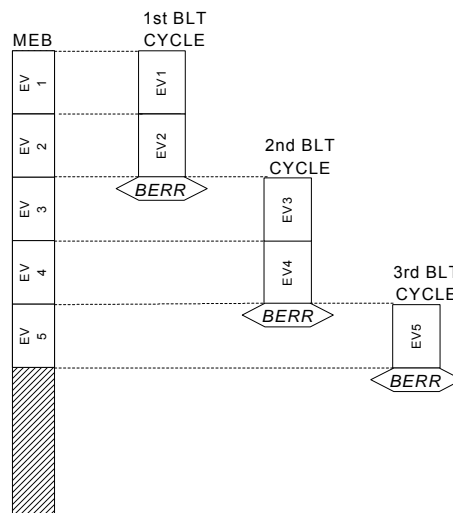

Fig. 4.6 Example of BLT data transfer with BERR and Event Aligned BLT enabled

4.6.6. **CBLT32/64 OUTPUT BUFFER readout**

The CBLT mode allows data readout from a set of modules in the crate. The readout starts from the first module of the set: it transfers its first event, then passes the *token* to the subsequent module via the IACKIN/IACKOUT daisy chain lines. If one module's Output Buffer is empty or *Inactive* (see § 6.12), the token is passed with no data transfer. If the data transfer is not completed by the first CBLT cycle, a second one may be attached to the first and so on until the last module in the set has transferred its last data: then it asserts BERR, which is automatically enabled when the CBLT is performed, thus completing the cycle.

CBLT64: if an odd number of words is transferred, the Board completes the event transfer by adding a filler.

4.6.7. D32 and BLT32/MBLT readout with Event FIFO enabled

The Event FIFO has been introduced in order to help the event readout from the Output Buffer, since the events length is unknown a priori. If the Event FIFO is enabled when an event is written in the Output Buffer, the FPGA writes in its internal FIFO (1 kword) a 32 bit word containing the event counter on 16 bit and the event number of words (see § 6.18).

This allows to acknowledge the number of words that compose the event, before starting the event readout. If the Event FIFO is enabled the events are readout in the following way:

- Readout one (or N) word from the Event FIFO
- Calculate Nw (or $\sum Nw$): number of words which compose the event (or N events)
- Readout Nw (or $\sum Nw$) in D32 /BLT32 / MBLT

Note that if the Event FIFO is enabled, for each event a 32 bit word is written into the Event FIFO: if it is never readout, then the board would become FULL after 1024 events, although the Output Buffer would be EMPTY (all the events were readout).

The Event FIFO Status Register and the Event FIFO Stored Register allow to know how many words are written into the Event FIFO (that, if it is correctly readout as described, correspond to the number of events stored into the Output Buffer).

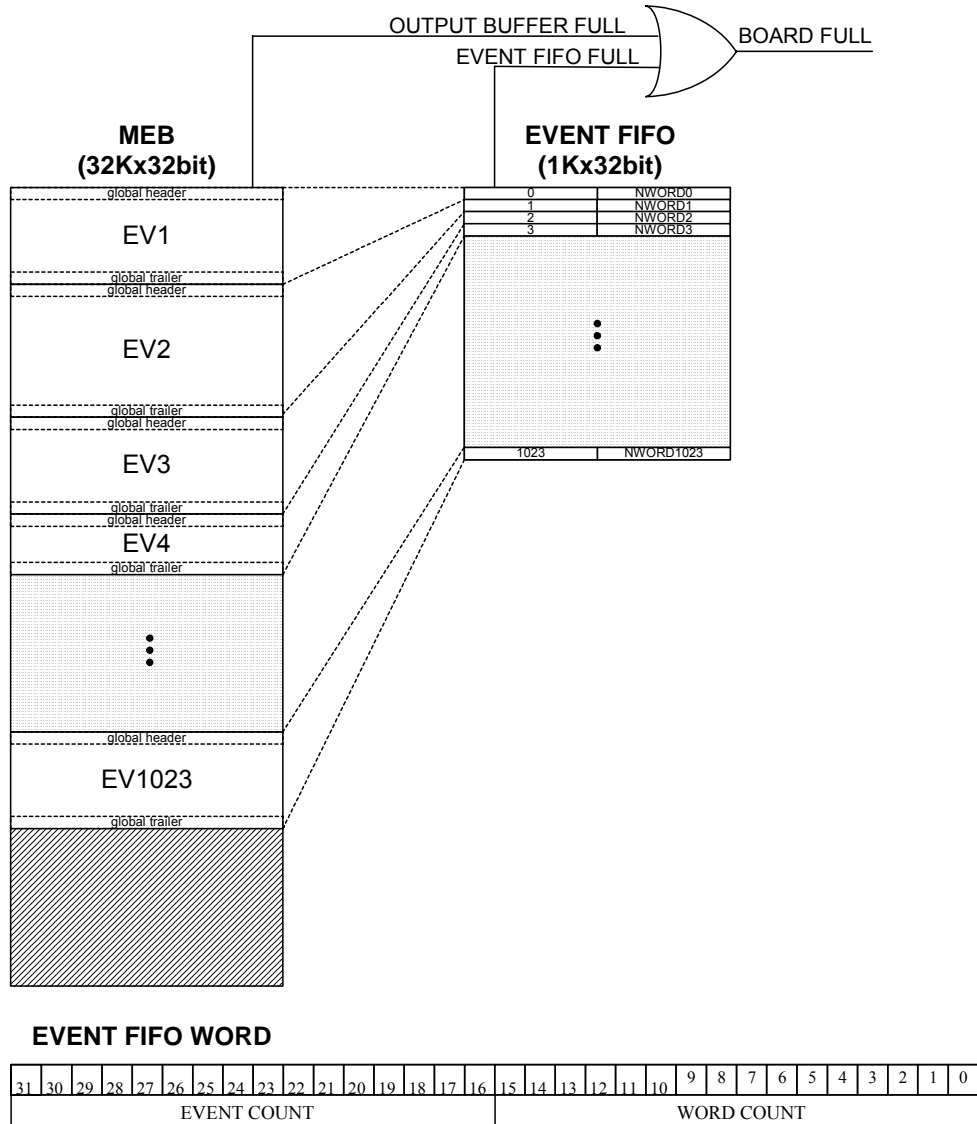

Fig. 4.7 MEB readout with Event FIFO enabled

4.7. Continuous Storage Mode data transfer

The Output Buffer can be readout via VME through either D32 or BLT32/BLT64 modes. The module has to be programmed in order to work in the required mode (see § 5.2.2). When hits are written into the Output Buffer; the DATA_READY bit in the Status Register (see § 6.4) is set to one when at least one datum is present in the buffer.

4.7.1. D32 OUTPUT BUFFER readout (Continuous Storage)

This readout mode can be performed in two ways:

- Set the Almost Full Level to N (see § 6.19); wait until the Almost Full bit in the Status Register is set to one then readout the N recorded words in D32 mode.
- Readout continuously from the buffer, removing the “fillers” via software.
- If BERR is enabled and the Output Buffer is empty, then the board asserts BERR without filler transfer.

4.7.2. **BLT32/64 OUTPUT BUFFER readout (Continuous Storage)**

- If BERR is disabled and the Output Buffer contains a number **N** of words smaller than $N_b/4$ (the number of words readout in one BLT cycle, being N_b the number of bytes per cycle), the module transfers its memory content, completed with $(N_b/4)-N$ fillers.
- If BERR is enabled the module produces a BERR signal once the last data in the Output Buffer has been transferred and no filler is added.

4.8. Reset logic

Different types of CLEAR or RESET operations are foreseen, according to the effects they have on the module and particularly on the registers. These are:

- Software CLEAR
- Hardware CLEAR
- Software RESET
- Hardware RESET
- Software EVENT COUNT RESET
- Hardware BUNCH COUNT RESET

4.8.1. **Software and Hardware CLEAR**

The CLEAR (whether hardware or software) clears the data off the Output Buffer, the event counter and performs a TDCs global reset, which does not erase the TDCs programming. A TDC global reset in fact clears all buffers in the TDCs, initialises all internal state machines and counters to their initial state and clears all detected error conditions.

The CLEAR can be forwarded in several ways:

1. Via software: Software Clear Register (see § 6.14)
2. When a write access to some Registers is performed (see table 4.2)
3. When a pulse is sent to the front panel CLR input.
4. When an OPCODE (see § 5) which foresees the TDC reprogramming is executed

The module's registers whose content is erased by a CLEAR are listed in Table 4.2.

4.8.2. Software RESET

The Software Reset performs the same actions of the CLEAR, moreover it resets some other registers and initializes the TDCs to the default configuration. This type of RESET can be forwarded by performing a write access to the Single Shot Reset Register. All the registers reset by a Software RESET are marked in the column SR (Software Reset) in Table 4.2.

4.8.3. Hardware RESET

The Hardware RESET performs the same actions as the Software RESET and, moreover, it resets some other registers. All the registers reset by a Hardware RESET are marked in the column HR (Hardware Reset) in Table 4.2.

This kind of RESET is performed:

1. at Power ON of the module;
2. via a VME RESET (SYS_RES).

After a reset (HW or SW) the module must thus be initialised.

4.8.4. Software Event Count RESET

The Software Event Count RESET does not perform the board's event counter reset but it loads the programmed event count offset into the TDCs event id counter. The Event Counter is also reset by the hardware Clear.

4.8.5. Hardware Bunch Count RESET

The Hardware Bunch Count RESET loads the default values (see § 5.3); it is forwarded by sending a pulse to the CRST front panel input.

Table 4.2: CLEAR/RESET effect on the Model V1190 A/B registers

Register content	CLR	SR	HR	Address
Output Buffer	✓	✓	✓	0x0000÷0x0FFC
Control Register (*)		✓	✓	0x1000
Status Register				0x1002
Interrupt Level			✓	0x100A
Interrupt Vector			✓	0x100C
GEO Address (*)			✓	0x100E
MCST Base Address (*)			✓	0x1010
MCST/CBLT Ctrl (*)			✓	0x1012
Module Reset				0x1014
Software Clear				0x1016
Software Event Reset				0x1018
Software Trigger				0x101A
Event Counter	✓	✓	✓	0x101C
Event Stored	✓	✓	✓	0x1020
Almost Full Level (*)		✓	✓	0x1022
BLT Event Number		✓	✓	0x1024
Firmware Revision				0x1026
Testreg		✓	✓	0x1028
Out Prog Control		✓	✓	0x102C
Micro (**)				0x102E
Micro Handshake				0x1030
Sel Flash			✓	0x1032
Flash				0x1034
Compensation SRAM Page		✓	✓	0x1036
Event FIFO	✓	✓	✓	0x1038
Event FIFO Stored	✓	✓	✓	0x103C
Event FIFO Status				0x103E
Dummy 32		✓	✓	0x1200
Dummy 16		✓	✓	0x1204

(*) A write access to these registers causes a module's CLEAR.

(**) See the OPCODE Table (§ 5.1)

4.9. Firmware upgrade

The board can store two firmware versions, called STD and BKP respectively; at Power On, a microcontroller reads the Flash Memory and programs the module with the firmware version selected via the J13 jumper (see § 3.6), which can be placed either on the STD position, or in the BKP position. It is possible to upgrade the board firmware via VME, by writing the Flash: for this purpose, download the software package available at: <http://www.caen.it/nuclear/product.php?mod=V1190A>

The package includes the new firmware release program file and a text file with C program examples which will guide the User through the development of the software necessary in order to update the Flash Memory.

N.B.: it is strongly suggested to upgrade ONLY one of the stored firmware revisions (generally the STD one): if both revision are simultaneously updated, and a failure occurs, it will not be possible to upload the firmware via VME again!

5. Operating codes

5.1. Programming capability

The module programming is performed by means of an on-board microcontroller. The User sends and receives instructions and data to/from the microcontroller via 16-bit OPCODE setup words. The handshake is the following:

Write Operation:

- the VME (master) tests the WRITE_OK bit in the Micro Handshake Register (see § 6.25); if the WO bit is set to 1, the VME can write a datum;
- the WO bit is automatically reset after the datum is written and will be set back to 1 when it will be possible to write another one;
- as soon as the WO bit is set back to 1, the VME can write another datum.

Read Operation:

- a valid datum can be read via VME only if the READ_OK (RO) bit in the Micro Handshake Register is set to 1 (see § 6.25);
- the RO bit is automatically reset after the datum is read out and will be set back to 1 when it will be possible to read another one;
- as soon as the RO bit is set back to 1, the VME can read another datum.

The OPCODE setup words have the following format:

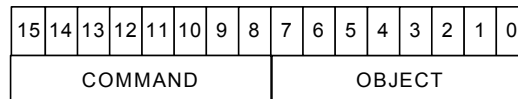

Fig. 5.1: Micro Register

The COMMAND field specifies the operation to perform, while the OBJECT field (when required) specifies the object over which the operation must be performed (e.g. the channel number). If the object refers to the channel number (for example OBJ = nn in Table 5.1), it can vary from 0 to either 7F (V1190 A) or 3F (V1190 B); if it refers to the HPTDC number (OBJ = 0n in Table 5.1), it can vary from 0 to either 3 (V1190 A) or 1 (V1190 B).

When the operation does not foresee an object, the OBJECT field is meaningless.

The communication with the microcontroller begins always by sending an OPCODE; if no operands are foreseen (nR = 0 and nW = 0) the cycle ends, otherwise the microcontroller remains in a wait status until the User has read or written all the foreseen operands.

Some opcodes imply the setup registers reprogramming when launched and thus a data clear, others imply the control registers reprogramming when launched (no data clear).

The following Table 5.1 contains, for each OPCODE, the symbolic name, the performed operation, the number of written and read operands, the number of significant bits and the foreseen reprogrammations.

Table 5.1: Operating codes list

COM	OBJ	CODE	SYMBOLIC	OPERATION	nW	nR	nbit	PR ⁹
ACQUISITION MODE								
00	-	00xx	TRG_MATCH	set trigger matching	-	-	-	s
01	-	01xx	CONT_STOR	set continuous storage	-	-	-	s
02	-	02xx	READ_ACQ_MOD	read acquisition mode	-	1	1	-
03	-	03xx	SET_KEEP_TOKEN	set keep_token	-	-	-	s
04	-	04xx	CLEAR_KEEP_TOKEN	clear keep token	-	-	-	s
05	-	05xx	LOAD_DEF_CONFIG	load default configuration	-	-	-	s
06	-	06xx	SAVE_USER_CONFIG	save User configuration	-	-	-	-
07	-	07xx	LOAD_USER_CONFIG	load User configuration	-	-	-	s
08	-	08xx	AUTOLOAD_USER_CONF	set auto load User configuration	-	-	-	-
09	-	09xx	AUTOLOAD_DEF_CONF	set auto load default configuration	-	-	-	-
TRIGGER								
10	-	10xx	SET_WIN_WIDTH	set window width	1	-	12	s
11	-	11xx	SET_WIN_OFFS	set window offset	1	-	12	s
12	-	12xx	SET_SW_MARGIN	set extra search margin	1	-	12	s
13	-	13xx	SET_REJ_MARGIN	set reject margin	1	-	12	s
14	-	14xx	EN_SUB_TRG	enable subtraction of trigger time	-	-	-	s
15	-	15xx	DIS_SUB_TRG	disable subtraction of trigger time	-	-	-	s
16	-	16xx	READ_TRG_CONF	read trigger configuration	-	5	49	-
TDC EDGE DETECTION & RESOLUTION								
22	-	22xx	SET DETECTION	enable paired meas. leading/ trailing edge	1	-	2	s
23	-	23xx	READ_DETECTION	read edge detection configuration	-	1	2	-
24	-	24xx	SET_TR_LEAD_LSB	set LSB of leading/trailing edge	1	-	2	s
25	-	25xx	SET_PAIR_RES	set leading time and width res. when pair	1	-	16	s
26	-	26xx	READ_RES	read resolution	-	1	16	-
28	-	28xx	SET_DEAD_TIME	set channel dead time between hits	1	-	2	s
29	-	29xx	READ_DEAD_TIME	read channel dead time between hits	-	1	2	-
TDC READOUT								
30	-	30xx	EN_HEAD_TRAILER	enable TDC header and TRAILER	-	-	-	s
31	-	31xx	DIS_HEAD_TRAILER	disable TDC header and TRAILER	-	-	-	s
32	-	32xx	READ_HEAD_TRAILER	read status TDC header and TRAILER	-	1	1	-
33	-	33xx	SET_EVENT_SIZE	set maximum number of hits per event	1	-	-	s
34	-	34xx	READ_EVENT_SIZE	read maximum number of hits per event	-	1	1	-

⁹ These opcodes imply the TDCs reprogramming when launched; “s” means that the setup registers will be reprogrammed, “c” means that the control registers will be reprogrammed.

35	-	35xx	EN_ERROR_MARK	enable TDC error mark	-	-	-	s
36	-	36xx	DIS_ERROR_MARK	disable TDC error mark	-	-	-	s
37	-	37xx	EN_ERROR_BYPASS	enable bypass TDC if error	-	-	-	s
38	-	38xx	DIS_ERROR_BYPASS	disable bypass TDC if error	-	-	-	s
39	-	39xx	SET_ERROR_TYPES	set TDC internal error type	1	-	11	s
3A	-	3Axx	READ_ERROR_TYPES	read TDC internal error type	-	1	11	-
3B	-	3Bxx	SET_FIFO_SIZE	set effective size of readout FIFO	1	-	3	s
3C	-	3Cxx	READ_FIFO_SIZE	read effective size of readout FIFO	-	1	3	-
CHANNEL ENABLE								
40	nn	40nn	EN_CHANNEL	enable channel nn	-	-	-	c
41	nn	41nn	DIS_CHANNEL	disable channel nn	-	-	-	c
42	-	42xx	EN_ALL_CH	enable all channels	-	-	-	c
43	-	43xx	DIS_ALL_CH	disable all channels	-	-	-	c
44	-	44xx	WRITE_EN_PATTERN	write enable pattern for channels	8	-	128	c
45	-	45xx	READ_EN_PATTERN	read enable pattern for channels	-	8	128	-
46	-	46xx	WRITE_EN_PATTERN32	write 32 bit enable pattern for channels	2	-	32	c
47	-	47xx	READ_EN_PATTERN32	read 32 bit enable pattern for channels	-	2	32	-
ADJUST								
50	-	50xx	SET_GLOB_OFFS	set global offset	2	-	17	s
51	-	51xx	READ_GLOB_OFFS	read global offset	-	2	17	-
52	nn	52nn	SET_ADJUST_CH	set channel nn adjust	1	-	8	s
53	nn	53nn	READ_ADJUST_CH	read channel nn adjust	-	1	8	-
54	-	54xn	SET_RC_ADJ	Set RC adjust of tdc 0n	1	-	12	s
55	-	55xn	READ_RC_ADJ	Read RC adjust of tdc 0n	-	1	12	-
56	-	56xn	SAVE_RC_ADJ	save RC adjust on EEPROM	-	-	-	-
MISCELLANEOUS								
60	0n	600n	READ_TDC_ID	read programmed ID of TDC 0n	-	2	32	-
61	-	61xx	READ_MICRO_REV	read firmware revision of microcontroller	-	1	8	-
62	-	62xx	RESET_DLL_PLL	reset DLL and PLL	-	-	-	s/c
ADVANCED								
70	nn	70nn	WRITE_SETUP_REG	write word nn into the scan path setup	1	-	16	-
71	nn	71nn	READ_SETUP_REG	read word nn into the scan path setup	-	1	16	-
72	-	72xx	UPDATE_SETUP_REG	load the scan path setup	-	-	-	s
73	-	73xx	DEFAULT_SETUP_REG	reload the default scan path setup	-	-	-	s
74	0n	740n	READ_ERROR_STATUS	read errors in the TDC 0n status	-	1	11	-
75	0n	750n	READ_DLL_LOCK	read the DLL LOCK bit of the TDC 0n	-	1	1	-
76	0n	760n	READ_STATUS_STREAM	read the TDC 0n status	-	4	62	-
77	nn	77nn	UPDATE_SETUP_TDC	load the scan path setup on TDC nn	-	-	-	-
DEBUG AND TEST								

C0	-	C0xx	Write EEPROM	write 1 byte into the EEPROM	2	-	16	-
C1	-	C1xx	Read EEPROM	read 1 byte from the EEPROM	1	1	8+8	-
C2	-	C2xx	Revision/Date μ controller fw	read the μ controller firmware revision/date	-	4	64	-
C3	-	C3xx	Write Spare	write a 16 bit spare variable	1	-	16	-
C4	-	C4xx	Read Spare	read a 16 bit spare variable	-	1	16	-
C5	-	C5xx	Enable Test Mode	enable TDC test mode	2	-	24	s
C6	-	C6xx	Disable Test Mode	disable TDC test mode	-	-	-	s
C7	0n	C70n	Set TDC Test output	set TDC 0n signal test output	1	-	4	s
C8	-	C8xx	Set DLL Clock	set DLL clock source	1	-	2	s
C9	0n	C90n	Read TDC Setup Scan Path	read all Setup Scan Path on TDC 0n	-	41	646	s

5.2. Acquisition mode opcodes

The following OPCODEs allow to select the acquisition mode (see § 2).

5.2.1. Set Trigger Matching Mode (CODE 00xx)

It allows to select the Trigger Matching Mode, described in § 2.4. Automatic_Reject and keep_token are automatically enabled (see § 5.2.4 and § 5.3.4).

5.2.2. Set Continuous Storage Mode (CODE 01xx)

It allows to select the Continuous Storage Mode, described in § 2.3. Automatic_Reject and trigger_time_subtraction are automatically disabled (see § 5.3.4 and § 5.3.5).

5.2.3. Read acquisition mode (CODE 02xx)

It allows to read the status of the Acquisition Mode settings. After this OPCODE a word must be read at the same location of the OPCODE itself. The microcontroller will remain in a wait status until a 16-bit word is read out. The least significant bit of this word is related to the Acquisition Mode according to the following:

- LSB = 1 → Trigger Matching Mode;
- LSB = 0 → Continuous Storage Mode.

5.2.4. Set keep_token (CODE 03xx)

It allows to program each TDC to load the data into the Output Buffer until the end of the event or until no more data are present. It is automatically enabled when using trigger matching.

5.2.5. Clear keep_token (CODE 04xx)

It allows to program each TDC to load the data into the Output Buffer one word at a time.

5.2.6. Load default configuration (CODE 05xx)

It allows to load the TDC default configuration of the following parameters:

- Trigger Matching = disabled;
- Window Width = 500 ns;
- Window Offset = -1 μ s;
- Reject margin = 100 ns;
- Extra search margin = 200 ns;
- All channels enabled.

If AUTO_LOAD is disabled (default) at Power-ON/Global Reset the module will be programmed in the default operation mode (see § 5.2.10).

5.2.7. Save User configuration (CODE 06xx)

It allows to save the current TDC user configuration that can be recalled at any time by the User. This Configuration concerns:

- Acquisition Mode;
- Window Width;
- Window Offset;
- Reject margin;
- Extra search margin;
- Enabled channels pattern.

If AUTO_LOAD is enabled at Power-ON/Global Reset the module will be programmed in the User operation mode (see § 5.2.9).

If the board is running a firmware revision < 0.3 then it is necessary to insert a delay >10 ms after a writing into the EEPROM, in order to let the writing procedure work properly.

5.2.8. Load User configuration (CODE 07xx)

It allows to load a TDC configuration previously saved by the User (see § 5.2.7).

5.2.9. Set auto load User configuration (CODE 08xx)

It allows to load automatically the TDC User configuration [AUTO_LOAD = 1] either at the next Power-ON or at the next Global RESET (see § 4.8.1).

If the board is running a firmware revision < 0.3 then it is necessary to insert a delay >10 ms after a writing into the EEPROM, in order to let the writing procedure work properly.

5.2.10. Set auto load default configuration (CODE 09xx)

It allows to load automatically the default configuration [AUTO_LOAD = 0] either at the next Power-ON or at the next Global RESET.

If the board is running a firmware revision < 0.3 then it is necessary to insert a delay > 10 ms after a writing into the EEPROM, in order to let the writing procedure work properly.

5.3. Trigger OPCODEs

The following OPCODEs allow to set or read some Trigger Matching Mode related parameters.

5.3.1. Set window width (CODE 10xx)

It allows to set the width of the match window. After this OPCODE is sent, a 16-bit word must be written at the same location of the OPCODE itself. The microcontroller will remain in a wait status until this 16-bit word is written. The value of the word can be set in a range from 1 to 4095 (significant bits: [0;11]), or hex FFF, taking into account the *Timing Constraints* (see § 2.4.1): the relevant window width is the word value times the clock period (25 ns).

Default setting: 0x14 → 500 ns

5.3.2. Set window offset (CODE 11xx)

It allows to set the offset of the match window with respect to the trigger itself, i.e. the time difference (expressed in clock cycles, 1 cycle = 25 ns) between the start of the match window and the trigger time. After this OPCODE is sent, a 16-bit word (12 significant bits) must be written at the same location of the OPCODE itself. The microcontroller will remain in a wait status until a 16-bit word is written. The window offset value must be set in the range from -2048 (hex 0x800) to +40 (hex 0x28). The offset and width value must be set according to the constraints described in § 2.4.1. The window offset is synchronised with the clock cycle, thus there could be a jitter of one clock cycle in the actual offset position.

Default setting: 0xFD8 → -1 μ s

5.3.3. Set extra search margin (CODE 12xx)

It allows to set the extra search field of the match window. After this OPCODE is sent, a 16-bit word must be written at the same location of the OPCODE itself. The microcontroller will remain in a wait status until a 16-bit word is written. The margin value (clock cycles) can be any 12 bit value (bits [12;15] are meaningless), though reasonable values are not greater than 50.

Default setting: 0x08 → 200 ns

5.3.4. Set reject margin (CODE 13xx)

It allows to set the reject margin, expressed in clock cycles. After this OPCODE is sent, a 16-bit word must be written at the same location of the OPCODE itself. The microcontroller will remain in a wait status until a 16-bit word is written. The margin value can be any 12 bit value (bits [12;15] are meaningless), 0 sets the margin at the beginning of the match window; it is recommended to set the margin ≥ 1 .

Default setting: 0x04 → 100 ns

5.3.5. Enable subtraction of trigger time (CODE 14xx)

It allows to enable the trigger time tag subtraction: in this operating mode the time measurements are referred to the beginning of the match window.

5.3.6. Disable subtraction of trigger time (CODE 15xx)

It allows to disable the trigger time tag subtraction: in this operating mode the time measurements are referred to the latest Bunch reset.

5.3.7. Read trigger configuration (CODE 16xx)

It allows to readout the trigger configuration. After this OPCODE is sent, five 16-bit words must be read at the MICRO register address. The microcontroller will remain in a wait status until five 16-bit (12 significant bits) word are read. The first word represents the Match Window Width, the second the window offset, the third the Extra Search Window Width and the fourth the Reject Margin. The fifth word's LSB has the following meaning:
LSB = 0 → trigger time subtraction disabled;
LSB = 1 → trigger time subtraction enabled.

5.4. TDC edge detection and resolution OPCODEs

These OPCODEs allow to set the measurement type on the TDC channels and their resolution.

5.4.1. Set edge detection configuration (CODE 22xx)

It allows to set the TDCs' edge detection. After this OPCODE is sent, a 16-bit word must be written at the MICRO register address. The microcontroller will remain in a wait status until a 16 bit word is written. This word's two LSBs have the following meaning:

00 → pair mode;
01 → only trailing;
10 → only leading;
11 → trailing and leading.

5.4.2. Read edge detection configuration (CODE 23xx)

It allows to readout the TDCs' edge detection configuration. After this OPCODE is sent, a 16-bit word must be read at the MICRO register address. The microcontroller will remain in a wait status until a 16 bit word is read. This word's two LSBs have the following meaning:

00 → pair mode;
01 → only trailing;
10 → only leading;
11 → trailing and leading.

5.4.3. Set LSB of leading/trailing edge (CODE 24xx)

It allows to set the LSB value in leading/trailing edge detection. After this OPCODE is sent, a 16-bit word must be written at the MICRO register address. The microcontroller will remain in a wait status until a 16 bit word is written. This word's bit 0 and bit 1 have the following meaning:

00 → 800 ps;
01 → 200 ps;
10 → 100 ps (default);
11 → not used.

5.4.4. Set leading time and width resolution when pair (CODE 25xx)

It allows to set the resolution of the leading edge arrival time measurement and of the pulse width in pair mode. After this OPCODE is sent, a 16-bit word must be written at the MICRO register address. The microcontroller will remain in a wait status until a 16 bit word is written. This word's bits [0;2] and bits [8;11] have the following meaning:

bits [0;2] (resolution of the leading edge arrival time):

000 → 100ps (default)
001 → 200ps
010 → 400ps
011 → 800ps
100 → 1.6ns
101 → 3.12ns
110 → 6.25ns
111 → 12.5ns

bits [8;11] (resolution of the pulse width):

0000 → 100ps (default)
0001 → 200ps
0010 → 400ps
0011 → 800ps
0100 → 1.6ns
0101 → 3.2ns
0110 → 6.25ns
0111 → 12.5ns
1000 → 25ns
1001 → 50ns
1010 → 100ns
1011 → 200ns
1100 → 400ns
1101 → 800ns
1110 → not valid
1111 → not valid

This opcode works properly if the pair mode is enabled (see § 5.4.1).

5.4.5. Read resolution (CODE 26xx)

It allows to readout the TDCs' resolution.

In leading/trailing edge detection, after this OPCODE is sent, a 16-bit word must be read at the MICRO register address. The microcontroller will remain in a wait status until a 16 bit word is read. This word's bit 0 and bit 1 have the following meaning:

00 → 800 ps;
01 → 200 ps;
10 → 100 ps.

In pair mode, after this OPCODE is sent, a 16-bit word must be read at the MICRO register address. The microcontroller will remain in a wait status until a 16 bit word is read. This word's bits [0;2] and bits [8;11] have the following meaning:

bits [0;2] (resolution of the leading edge arrival time):

000 → 100ps
001 → 200ps
010 → 400ps
011 → 800ps
100 → 1.6ns
101 → 3.12ns
110 → 6.25ns
111 → 12.5ns

bits [8;11] (resolution of the pulse width):

0000 → 100ps
0001 → 200ps
0010 → 400ps
0011 → 800ps
0100 → 1.6ns
0101 → 3.2ns
0110 → 6.25ns
0111 → 12.5ns
1000 → 25ns
1001 → 50ns
1010 → 100ns
1011 → 200ns
1100 → 400ns
1101 → 800ns
1110 → not valid
1111 → not valid

5.4.6. Set channel dead time between hits (CODE 28xx)

It allows to set the double hit resolution (i.e. the dead time between two subsequent hits). After this OPCODE is sent, a 16-bit word must be written at the MICRO register address. The microcontroller will remain in a wait status until this 16-bit word is written. This word's two LSBs allow the following settings:

00 → ~5ns (default);
01 → ~10ns;

10 → ~30ns;
11 → ~100ns.

5.4.7. Read channel dead time between hits (CODE 29xx)

It allows to readout the double hit resolution (i.e. the dead time between two subsequent hits). After this OPCODE is sent, a 16-bit word must be read at the MICRO register address. The microcontroller will remain in a wait status until this 16-bit word is read. This word's two LSBs have the following meaning:

00 → ~5ns;
01 → ~10ns;
10 → ~30ns;
11 → ~100ns.

5.5. TDC Readout OPCODEs

The following OPCODEs allow some settings operating with the Trigger Matching Mode (TDCs' Header and Trailer, events' composition).

5.5.1. Enable TDC Header and Trailer in readout (CODE 30xx)

It allows to enable the TDCs' Header and Trailer during data readout.

5.5.2. Disable TDC Header and Trailer in readout (CODE 31xx)

It allows to disable the TDCs' Header and Trailer during data readout.

5.5.3. Read TDC Header and Trailer status (CODE 32xx)

It allows to readout whether the TDCs' Header and Trailer are enabled or not. After this OPCODE is sent, a 16-bit word must be read at the MICRO register address. The microcontroller will remain in a wait status until this 16-bit word is read. This word's LSB has the following meaning:

LSB = 0 → TDC Header/ Trailer disabled;
LSB = 1 → TDC Header/ Trailer enabled.

5.5.4. Set maximum number of hits per event (CODE 33xx)

It allows to set the maximum number of hits for each TDCs' event (thus limiting the *event size*). After this OPCODE is sent, a 16-bit word must be written at the MICRO register address. The microcontroller will remain in a wait status until this 16-bit word is written. This word's four LSBs allow the following settings:

0000 → 0;
0001 → 1;
0010 → 2;
0011 → 4;
0000 → 8;
0101 → 16;
0110 → 32;
0111 → 64;
1000 → 128;
1001 → no limit (default);
1010÷1111 → meaningless.

If a number of hits larger than the allowed is arriving, then the TDC generates an error word which is placed at the end of the event (before the Trailer, if enabled); in particular the error flag value will be 0x1000 (which means "*size limit exceeded*", see § 6.2.1 and [4], page 22).

5.5.5. Read maximum number of hits per event (CODE 34xx)

It allows to readout the maximum number of hits for each TDCs' event (event size). After this OPCODE is sent, a 16-bit word must be read at the MICRO register address. The microcontroller will remain in a wait status until this 16-bit word is read. This word's four LSBs have the following meaning:

0000 → 0;
0001 → 1;
0010 → 2;
0011 → 4;
0100 → 8;
0101 → 16;
0110 → 32;
0111 → 64;
1000 → 128;
1001 → no limit;
1010÷1111 → meaningless.

5.5.6. Enable TDC error mark (CODE 35xx)

It allows the TDCs to put an error mark into the events when a global error occurs (default).

5.5.7. Disable TDC error mark (CODE 36xx)

Does not allow the TDCs to put an error mark into the events when a global error occurs.

5.5.8. Enable bypass TDC if error (CODE 37xx)

Enables the TDCs' bypass when a global error occurs.

5.5.9. Disable bypass TDC if error (CODE 38xx)

Disables the TDCs' bypass when a global error occurs.

5.5.10. Enable TDC internal error type (CODE 39xx)

It allows to enable the TDCs' internal error types for the production of the global error signal. After this OPCODE is sent, a 16-bit word must be written at the MICRO register address. The microcontroller will remain in a wait status until this 16-bit word is written. This word's 11 LSB allow (each one independently) to enable one type of internal error (bit set to one: error enabled). Refer to [4], page 33, for errors description.

15	14	13	12	11	10	9	8	7	6	5	4	3	2	1	0						
											Jtag instruction parity error	Control parity error	Set up parity error	Readout state error	Readout fifo parity error	Trigger matching error (state error)	Trigger fifo parity error	L1 buffer parity error	Channel select error (synchronisation error)	Coarse error (parity error on coarse count)	Vernier error (DLL unlocked or excessive jitter)

5.5.11. Read enabled TDC internal error type (CODE 3Axx)

It allows to readout the TDCs' enabled internal error types for the production of the global error signal. After this OPCODE is sent, a 16-bit word must be read at the MICRO register address. The microcontroller will remain in a wait status until this 16-bit word is read. This word's 11 LSB indicate (each one independently) whether the corresponding errors are enabled or not. Refer to [4], page 33, for errors description.

5.5.12. Set effective size of readout FIFO (CODE3Bxx)

It allows to set the actual size of the L1 buffer (see § 2.1.1). After this OPCODE is sent, a 16-bit word must be written at the MICRO register address. The microcontroller will remain in a wait status until a 16 bit word is written. This word's bits [0;2] have the following meaning:

000 → 2 words
001 → 4 words
010 → 8 words
011 → 16 words
100 → 32 words
101 → 64 words
110 → 128 words
111 → 256 words (default)

5.5.13. Read effective size of readout FIFO (CODE3Cxx)

It allows to read the actual size of the L1 buffer (see § 2.1.1). After this OPCODE is sent, a 16-bit word must be read at the MICRO register address. The microcontroller will remain in a wait status until a 16 bit word is read. This word's bits [0;2] have the following meaning:

000 → 2 words
001 → 4 words
010 → 8 words
011 → 16 words
100 → 32 words
101 → 64 words
110 → 128 words
111 → 256 words (default)

5.6. Channel enable OPCODES

The following OPCODEs allow either to enable or to disable individually the TDCs' channels. These operations can be performed *run time* (i.e. even during TDCs' operation).

5.6.1. Enable channel *nn* (CODE 40nn)

It allows to enable the channel *nn* (in the range %00÷%7F, corresponding to 0÷127, for the V1190 A; %00÷%3F, corresponding to 0÷63, for the V1190 B).

5.6.2. Disable channel *nn* (CODE 41nn)

It allows to disable the channel *nn* (in the range %00÷%7F, corresponding to 0÷127, for the V1190 A; %00÷%3F, corresponding to 0÷63, for the V1190 B).

5.6.3. Enable all channels (CODE 42xx)

It allows to enable all the channels.

5.6.4. Disable all channels (CODE 43xx)

It allows to disable all the channels.

5.6.5. Write enable pattern (CODE 44xx)

It allows to write the channel enable pattern. After this OPCODE is sent, eight 16-bit words (four 16-bit words for Mod. V1190B) must be written at the MICRO register address. The microcontroller will remain in a wait status until these 16-bit words are written. These words' bits allows the following settings:

word 0: bit 0 → channel 0
word 0: bit 1 → channel 1
:
word 0: bit 15 → channel 15

word 1: bit 0 → channel 16
word 1: bit 1 → channel 17
:
word 1: bit 15 → channel 31

word 7: bit 0 → channel 112
word 7: bit 1 → channel 113
:
word 7: bit 15 → channel 127

- bit $n = 0$ → channel n disabled;
- bit $n = 1$ → channel n enabled.

5.6.6. Read enable pattern (CODE 45xx)

It allows to readout the channel enable pattern. After this OPCODE is sent, eight 16-bit words (four 16-bit words for Mod. V1190B) will be read at the MICRO register address. The microcontroller will remain in a wait status until these 16-bit words are read. These words' bits have the following meaning:

word 0: bit 0 → channel 0
word 0: bit 1 → channel 1
:
word 0: bit 15 → channel 15

word 1: bit 0 → channel 16
word 1: bit 1 → channel 17
:
word 1: bit 15 → channel 31

word 7: bit 0 → channel 112

word 7: bit 1 → channel 113
:
word 7: bit 15 → channel 127
- bit $n = 0$ → channel n disabled;
- bit $n = 1$ → channel n enabled.

5.6.7. Write enable pattern 32 (CODE 460n)

It allows to write the channel enable pattern of the TDC n (V1190 A → n : %0÷%3; V1190 B → n : %0÷%1). After this OPCODE is sent, two 16-bit words must be written at the MICRO register address. The microcontroller will remain in a wait status until these 16-bit words are written. These words' bits allows the following settings:

word 0: bit 0 → channel 0 of TDC n
word 0: bit 1 → channel 1 of TDC n
:
word 0: bit 15 → channel 15 of TDC n

word 1: bit 0 → channel 16 of TDC n
word 1: bit 1 → channel 17 of TDC n
:
word 1: bit 15 → channel 31 of TDC n
- bit $n = 0$ → channel n disabled;
- bit $n = 1$ → channel n enabled.

5.6.8. Read enable pattern 32 (CODE 470n)

It allows to readout the channel enable pattern of the TDC n (V1190 A → n : %0÷%3; V1190 B → n : %0÷%1). After this OPCODE is readout, two 16-bit words will be read at the MICRO register address. The microcontroller will remain in a wait status until these 16-bit words are read. These words' bits have the following maeaning:

word 0: bit 0 → channel 0 of TDC n
word 0: bit 1 → channel 1 of TDC n
:
word 0: bit 15 → channel 15 of TDC n

word 1: bit 0 → channel 16 of TDC n
word 1: bit 1 → channel 17 of TDC n
:
word 1: bit 15 ⇒ channel 31 of TDC n
- bit $n = 0$ → channel n disabled;
- bit $n = 1$ → channel n enabled.

5.7. Adjust OPCODES

The following OPCODEs allow to set or readout a global offset common to all channels (coarse and fine counters) and the offset adjustment for each channel.

5.7.1. Set global offset (CODE 50xx)

It allows to add a global offset to the coarse and fine (vernier) counters. After this OPCODE is sent, two 16-bit words must be written at the MICRO register address. The microcontroller will remain in a wait status until these two 16-bit word are written. The first word carries the coarse counter offset (11 significant bits), the second one carries the fine counter offset (5 significant bits).

5.7.2. Read global offset (CODE 51xx)

It allows to readout the global offset of the coarse and fine (vernier) counters. After this OPCODE is sent, two 16-bit words must be read at the MICRO register address. The microcontroller will remain in a wait status until these two 16-bit word are read. The first word carries the coarse counter offset (11 significant bits), the second one carries the fine counter offset (5 significant bits).

5.7.3. Set channel *nn* adjust (CODE 52nn)

It allows to add a positive offset to the channel *nn* (in the range %00÷%7F, corresponding to 0÷127, for the V1190 A; %00÷%3F, corresponding to 0÷63, for the V1190 B). After this OPCODE is sent, a 16-bit word must be written at the MICRO register address. The microcontroller will remain in a wait status until this 16-bit word is written. The written value ranges from 0 to 255 LSBs (bits 8 to 15 are meaningless).

5.7.4. Read channel *nn* adjust (CODE 53nn)

It allows to read out the positive offset of the channel *nn* (in the range %00÷%7F, corresponding to 0÷127, for the V1190 A; %00÷%3F, corresponding to 0÷63, for the V1190 B). After this OPCODE is sent, a 16-bit word must be read at the MICRO register address. The microcontroller will remain in a wait status until this 16-bit word is read. The read value ranges from 0 to 255 LSBs (bits 8 to 15 are meaningless).

5.7.5. Set RC adjust of TDC *n* (CODE 540n)

Not used.

5.7.6. Read RC adjust of TDC *n* (CODE 550n)

Not used.

5.7.7. *Save RC adjust on EEPROM (CODE 56xx)*

Not used.

5.8. Miscellaneous

5.8.1. *Read ID code of TDC n (CODE 600n)*

It allows to readout the TDC ID code for the TDC **n** (n: %0÷%3 for the V1190 A; n: %0÷%1 for the V1190 B). After this OPCODE is sent, a 16-bit word must be read at the MICRO register address. The microcontroller will remain in a wait status until this 16-bit word is read. The ID code is 0x8470DAC**X**, where **X** depends on the HPTDC revision: for example **X** = E for the revision 1.3.

5.8.2. *Read firmware rev. of microcontroller (CODE 61xx)*

It allows to readout the firmware revision of the microcontroller. After this OPCODE is sent, a 16-bit word must be read at the MICRO register address (bits 8 to 15 are meaningless). The microcontroller will remain in a wait status until this 16-bit word is read. If the present firmware release is 1.3, the readout word is 0x0013 [8 bit].

5.8.3. *Reset PLL and DLL (CODE 62xx)*

It allows to reset the TDCs' PLL (Phase Locked Loop) and DLL (Delay Locked Loop), refer to 2.1.

5.9. Advanced

These OPCODEs refer to some tests and advanced modes. It must be noticed that the setup scan path used for the HPTDC programming/configuration, composed by 646 significant bits plus one parity bit, is memorised into a 40 (16 bit) word array. For example the Trigger Matching Mode is enabled by bit 639, which is bit 15 of word 39. These OPCODEs allow to configure also parameters which are not handled by dedicated OPCODEs; for further information, please refer to the TDCs' handbook ("*High performance general purpose TDC specification*", J. Christiansen CERN/EP-MIC, [4]). The parity bit must not be set by the User, since it is automatically set during the programmation.

5.9.1. *Write word nn into the Scan Path Setup (CODE 70nn)*

It allows to write the word **nn** (nn: %0÷%0x28) into the Scan Path Setup. After this OPCODE is sent, a 16-bit word must be written at the MICRO register address. The microcontroller will remain in a wait status until this 16-bit word is written. It must be noticed that the new datum is memorised via this OPCODE but not actually loaded into the HPTDC: the CODE 72xx must be used for this purpose.

5.9.2. Read word nn into the Scan Path Setup (CODE 71nn)

It allows to read the word nn (nn : %0÷%0x28) from the Scan Path Setup. After this OPCODE is sent, a 16-bit word must be read at the MICRO register address. The microcontroller will remain in a wait status until this 16-bit word is read.

5.9.3. Load the Scan Path Setup (CODE 72xx)

It allows to load into the TDCs the current Scan Path Setup.

5.9.4. Reload the default Scan Path Setup (CODE 73xx)

It allows to load into the TDCs the default Scan Path Setup.

5.9.5. Read errors in the TDC n status (CODE 740n)

It allows to read errors in the TDC n (n : %0÷%3 for the V1190 A; n : %0÷%1 for the V1190 B). After this OPCODE is sent, a 16-bit word must be read at the MICRO register address. The microcontroller will remain in a wait status until this 16-bit word is read. This word's 11 LSB are set to one if the corresponding internal error (see § 5.5.10) has occurred, zero otherwise.

5.9.6. Read the DLL LOCK bit of the TDC n (CODE 750n)

It allows to read DLL LOCK bit status in the TDC n (n : %0÷%3 for the V1190 A; n : %0÷%1 for the V1190 B). After this OPCODE is sent, a 16-bit word must be read at the MICRO register address. The microcontroller will remain in a wait status until this 16-bit word is read. This word's LSB indicates the DLL LOCK status:

LSB = 0 → DLL not in LOCK;

LSB = 1 → DLL in LOCK.

5.9.7. Read the TDC n status (CODE 760n)

It allows to read the TDC n (n : %0÷%3 for the V1190 A; n : %0÷%1 for the V1190 B) status. After this OPCODE is sent, 4 16-bit words must be read at the MICRO register address. The microcontroller will remain in a wait status until four 16-bit words are read (the TDC status is composed by 62 bit, see [4], page 40).

5.9.8. Load the Scan Path Setup in the TDC n (CODE 770n)

It allows to load only into the TDC n the current Scan Path Setup.

5.10. Test and Debug

5.10.1. Write EEPROM (CODE C0xx)

It allows to write one byte into the Microcontroller EEPROM (512 byte). After this OPCODE is sent, two 16-bit words must be written at the MICRO register address. The microcontroller will remain in a wait status until these two 16-bit word are written:

cycle 1: addressing;
cycle 2: datum [8 significant bits].

Part of the EEPROM is used for the storage of some configuration parameters [from 0x0 to 0x28]; write cycles at these addresses should be thus avoided. Such addresses are assigned as follows:

ADDRESS	DATA
0x02	Flag EEPROM Not Empty
0x03	Board Version
0x04	Microcontroller Firmware Revision
0x05	Microcontroller Firmware Day
0x06	Microcontroller Firmware Month
0x07	Microcontroller Firmware Year
0x08	Autoload
0x09 : 0x0D	Reserved
0x0E : 0x11	Not used in this module
0x18 : 0x28	User Configuration

If the board is running a firmware revision < 0.3 then it is necessary to insert a delay >10 ms after a writing into the EEPROM, in order to let the writing procedure work properly.

5.10.2. Read EEPROM (CODE C1xx)

It allows to read one byte from the Microcontroller EEPROM (512 byte).

After this code is sent the microcontroller expects one write cycle and one read cycle: a 16-bit word must be written at the MICRO register address: the microcontroller will remain in a wait status until this 16-bit word is written; then a 16-bit word must be read at the MICRO register address: the microcontroller will remain in a wait status until this 16-bit word is read.

cycle 1 (w) → addressing;
cycle 2 (r) → datum (8 significant bits, bits [8..15] are meaningless)

5.10.3. Revision and Date Microcontroller firmware (CODE C2xx)

It allows to read the Microcontroller firmware revision and date: after this OPCODE is sent, four 16-bit words must be read at the MICRO register address. The microcontroller will remain in a wait status until these four 16-bit word are written. The words meaning is respectively:

1st word → revision
2nd word → day
3rd word → month

4th word → year

5.10.4. Write Spare (CODE C3xx)

It allows to write a 16 bit spare variable, for testing the correct communication with the microcontroller: after this OPCODE is sent, one 16-bit word must be written at the MICRO register address. The microcontroller will remain in a wait status until this 16-bit word is written.

5.10.5. Read Spare (CODE C4xx)

It allows to read a 16 bit spare variable, for testing the correct communication with the microcontroller: after this OPCODE is sent, a 16-bit word must be read at the MICRO register address. The microcontroller will remain in a wait status until this 16-bit word is read (Default = 0x5555).

5.10.6. Enable Test Mode (CODE C5xx)

It allows to enable the TDC test mode. The module must be operating in Trigger Matching Mode; when a trigger arrives, a special test word is inserted in the event, between the Header and the Trailer (if enabled), replacing the data. The number of test words is fixed by the maximum number of hit per event (see § 5.5.4). After this OPCODE is sent, two 16-bit words must be written at the MICRO register address. The microcontroller will remain in a wait status until these two 16-bit words are written. Such words represent the 24 LSBs of the test word:

1st write cycle: bits [15..0] of test word
2nd write cycle (8 significant bits): bits [23..16] of test word.

The test word format is the following:

31	30	29	28	27	26	25	24	23	22	21	20	19	18	17	16	15	14	13	12	11	10	9	8	7	6	5	4	3	2	1	0
0	0	1	0	0	0	TDC	TEST_WORD_HIGH								TEST_WORD_LOW																

Fig. 5.2: Output Buffer: the Test word

5.10.7. Disable Test Mode (CODE C6xx)

It allows to disable the TDC test mode.

5.10.8. Set TDC Test output (CODE C7xn)

It allows to set TDC signal test output: after this code is sent, one 16-bit word must be written at the MICRO register address (4 significant bits, default : 1110 = constant_low). The microcontroller will remain in a wait status until this 16-bit word is written (4 significant bits):

default : 1110 → constant_low

Bits [4..15] are meaningless, see also [4], pag 27.

5.10.9. Set DLL Clock (CODE C8xx)

It allows to set DLL clock source: after this code is sent, one 16-bit word must be written at the MICRO register address. The microcontroller will remain in a wait status until this 16-bit word is written. Bits [0,1] have the following meaning:

- 00 → direct 40 MHz clock (low resolution)
- 01 → from PLL 40 MHz clock (low resolution)
- 00 → from PLL 160 MHz clock (medium resolution)
- 00 → from PLL 320 MHz clock (high resolution)

Bits [2..15] are meaningless.

5.10.10. Read TDC Setup Scan Path (CODE C9xn)

It allows to read all Setup Scan Path on TDC n: after this code is sent, forty one 16-bit words must be read at the MICRO register address. The microcontroller will remain in a wait status until these forty one 16-bit words are read.

41 read cycles → 646 significant bits + 1 bit for the parity.

6. VME Interface

6.1. Register address map

The Address map for the Model V1190 A/B is listed in Table 6.1. All register addresses are referred to the Base Address of the board, i.e. the addresses reported in the Tables are the offsets to be added to the board Base Address.

Table 6.1: Address Map for the Model V1190 A/B

ADDRESS	REGISTER/CONTENT	ADDR	DATA	R/W	
Base + %0000÷%0FFC	Output Buffer (**)	A24/A32	D32	read only	
Base + %1000	Control Register (*) (***)	A24/A32	D16	read/write	
Base + %1002	Status Register	A24/A32	D16	read only	
Base + %100A	Interrupt Level (*)	A24/A32	D16	read/write	
Base + %100C	Interrupt Vector (*)	A24/A32	D16	read/write	
Base + %100E	Geo Address_Register (***)	A24/A32	D16	read/write	
Base + %1010	MCST Base Address(***)	A24/A32	D16	read/write	
Base + %1012	MCST Control(***)	A24/A32	D16	read/write	
Base + %1014	Module Reset (*)	A24/A32	D16	write only	
Base + %1016	Software Clear (*)	A24/A32	D16	write only	
Base + %1018	Software Event Reset (*)	A24/A32	D16	write only	
Base + %101A	Software Trigger (*)	A24/A32	D16	write only	
Base + %101C	Event Counter	A24/A32	D32	read only	
Base + %1020	Event Stored	A24/A32	D16	read only	
Base + %1022	Almost Full Level(*) (***)	A24/A32	D16	read/write	
Base + %1024	BLT event number(*)	A24/A32	D16	read/write	
Base + %1026	Firmware revision	A24/A32	D16	read only	
Base + %1028	Testreg(*)	A24/A32	D32	read/write	
Base + %102C	Output prog control(*)	A24/A32	D16	read/write	
Base + %102E	Micro(*)	A24/A32	D16	read/write	
Base + %1030	Micro Handshake	A24/A32	D16	read only	
Base + %1032	Select Flash(****)	A24/A32	D16	read/write	
Base + %1034	Flash memory(****)	A24/A32	D16	read/write	
Base + %1036	Sram Page	A24/A32	D16	read/write	
Base + %1038	Event FIFO	A24/A32	D32	read only	
Base + %103C	Event FIFO Stored	A24/A32	D16	read only	
Base + %103E	Event FIFO Status	A24/A32	D16	read only	
Base + %1200	Dummy32(*)	A24/A32	D32	read/write	
Base + %1204	Dummy16(*)	A24/A32	D16	read/write	
Base + %4000÷%41FE	Configuration ROM(****)	A24/A32	D16	read only	
Base + %8000÷%81FE	Compensation Sram(****)	A24/A32	D16	read only	
VX1190 A/B only	Base + %1004	ADER_32	A24/A32	D16	read/write
	Base + %1006	ADER_24	A24/A32	D16	read/write
	Base + %1008	Enable ADER	A24/A32	D16	read/write

(*) MSCT access allowed.

(**) BLT/CBLT access allowed.

(***) A write access to these registers causes a module's CLEAR.

(****) See Appendix A

6.1.1. Configuration ROM

The following registers contain some module information as shown in table 6.2, they are D16 accessible (read only):

- **OUI:** manufacturer identifier (IEEE OUI)
- **Version:** purchased version
- **Board ID:** Board identifier
- **Revision:** hardware revision identifier
- **Serial MSB:** serial number (MSB)
- **Serial LSB:** serial number (LSB)

Table 6.2: ROM Address Map for the Model V1190 A/B

Description	Address	Content	
checksum	0x4000	0xA4	
checksum_length2	0x4004	0x00	
checksum_length1	0x4008	0x00	
checksum_length0	0x400C	0x20	
constant2	0x4010	0x83	
constant1	0x4014	0x84	
constant0	0x4018	0x01	
c_code	0x401C	0x43	
r_code	0x4020	0x52	
oui2	0x4024	0x00	
oui1	0x4028	0x40	
oui0	0x402C	0xE6	
vers	0x4030	A	B
		0x00	0x01
board2	0x4034	0x00	
board1	0x4038	0x04	
board0	0x403C	0xA6	
revis3	0x4040	0x00	
revis2	0x4044	0x00	
revis1	0x4048	0x00	
revis0	0x404C	0x01	
sernum1	0x4080	0x00	
sernum0	0x4084	0x16	

These data are written into one Flash page; at Power ON the Flash content is loaded into the Configuration ROM (see Appendix A).

6.2. Output Buffer Register

(Base Address + 0x0000 ÷ 0x0FFC, read only, D32)

Settings upon the acquisition modes (i.e. the module's programming) can be performed as described in § 5.2.

6.2.1. Trigger Matching Mode

Each time a trigger signal occurs, the hits accumulated by the enabled channels are loaded into the Output Buffer where they are organised in events.

Each event consists of:

- the **Global Header** (32 bit), that contains the geographical address and the event counter (up to 22 bit);
- the **events** collected by the four TDCs, each of them composed as follows:
 - a **TDC Header** (if enabled);
 - the **TDC Measurements** (caught inside the Trigger Matching Window);
 - the eventual **TDC Errors** (if enabled);
 - the **TDC Trailer** (if enabled);
- the **Extended Trigger Time Tag** (optional) which contains the trigger arrival time relatively to the Count Reset (LSB = 800 ns).
- the **Trailer**, which contains the geographical address, the event words counter (16 bit), and a "status" (3 bit).

Bits [31,27] identify the word type:

01000→Global Header

10000→Global TRAILER

00xxx→TDC Data (TDC Header, TDC Measurement, TDC Error, TDC TRAILER)

10001→Global Trigger Time Tag

Bits [29÷27] identify the TDC Data type:

001→TDC Header

000→TDC Measurement

100→TDC Error

011→TDC TRAILER

31	30	29	28	27	26	25	24	23	22	21	20	19	18	17	16	15	14	13	12	11	10	9	8	7	6	5	4	3	2	1	0
0	1	0	0	0	EVENT COUNT																GEO										

Fig. 6.1: Output Buffer: the Global Header

31	30	29	28	27	26	25	24	23	22	21	20	19	18	17	16	15	14	13	12	11	10	9	8	7	6	5	4	3	2	1	0
0	0	0	0	1	TDC	EVENT ID										BUNCH ID															

Fig. 6.2: Output Buffer: the TDC Header

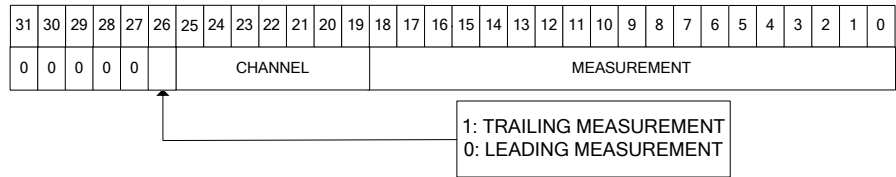

Fig. 6.3: Output Buffer: the TDC Measurement

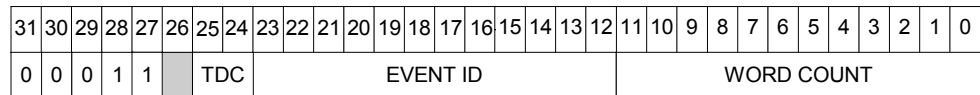

Fig. 6.4: Output Buffer: the TDC Trailer

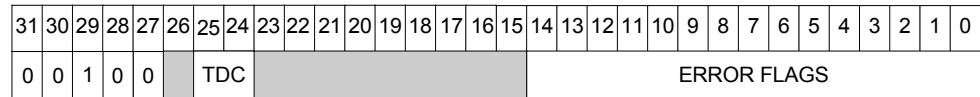

Fig. 6.5: Output Buffer: the TDC Error

Error flags:

- [0]: Hit lost in group 0 from read-out FIFO overflow.
- [1]: Hit lost in group 0 from L1 buffer overflow
- [2]: Hit error have been detected in group 0.
- [3]: Hit lost in group 1 from read-out FIFO overflow.
- [4]: Hit lost in group 1 from L1 buffer overflow
- [5]: Hit error have been detected in group 1.
- [6]: Hit data lost in group 2 from read-out FIFO overflow.
- [7]: Hit lost in group 2 from L1 buffer overflow
- [8]: Hit error have been detected in group 2.
- [9]: Hit lost in group 3 from read-out FIFO overflow.
- [10]: Hit lost in group 3 from L1 buffer overflow
- [11]: Hit error have been detected in group 3.
- [12]: Hits rejected because of programmed event size limit
- [13]: Event lost (trigger FIFO overflow).
- [14]: Internal fatal chip error has been detected.

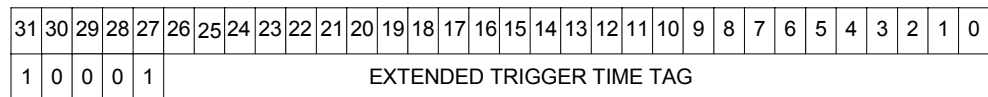

Fig. 6.6: Output Buffer: the Extended Trigger Time Tag

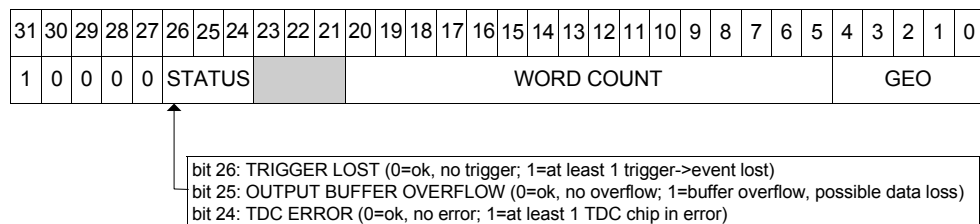

Fig. 6.7: Output Buffer: the Trailer

6.2.1.1. TDC Measurement

LEADING MEASUREMENT:

Single edge:

18	17	16	15	14	13	12	11	10	9	8	7	6	5	4	3	2	1	0
LEADING TIME																		

Leading time→the Leading Edge is measured with the programmed resolution

Pair measurement:

18	17	16	15	14	13	12	11	10	9	8	7	6	5	4	3	2	1	0
WIDTH							LEADING TIME											

Leading time→the Leading Edge is measured with the programmed resolution

Width→the pulse width is measured with the programmed resolution

TRAILING MEASUREMENT:

18	17	16	15	14	13	12	11	10	9	8	7	6	5	4	3	2	1	0
TRAILING TIME																		

Trailing time→the Trailing Edge is measured with the programmed resolution

6.2.2. Continuous Storage Mode

The digits of the output data have the structure depicted in Fig. 6.3.

6.2.3. Filler

The Filler Data, used either to complete BLT transfers (see § 4.6) or when no data are present in the buffer, are identified by Bit [31,27]→11000

31	30	29	28	27	26	25	24	23	22	21	20	19	18	17	16	15	14	13	12	11	10	9	8	7	6	5	4	3	2	1	0
1	1	0	0	0																											

Fig. 6.8: Output Buffer: the Filler

6.3. Control Register

(Base Address + 0x1000, read/write, D16)

This register allows performing some general settings of the module.

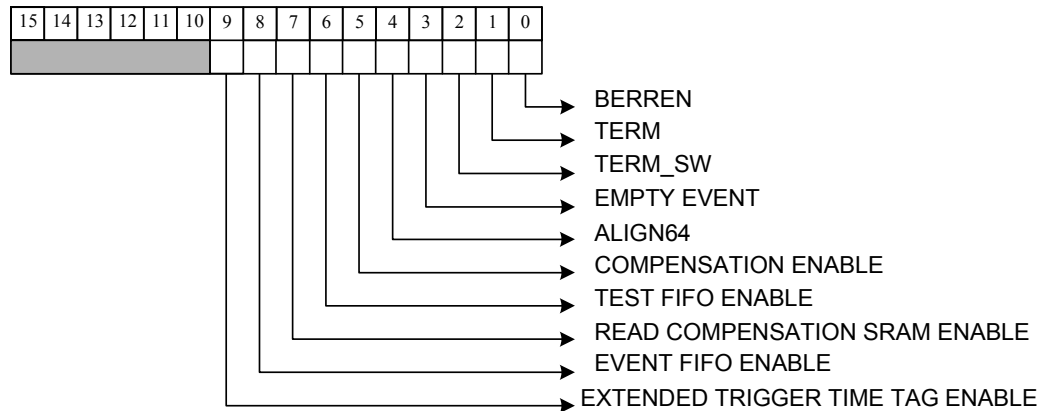

Fig. 6.9: Control Register

- BERR EN:** Bus Error enable bit. Used in D32 and Block Transfer mode.
 = 0 the module sends a DTACK signal until the CPU inquires the module (default);
 = 1 the module is enabled either to generate a Bus error to finish a block transfer or during the empty buffer read out in D32
- TERM:** Set the software termination status; it works only if TERM SW = 1
 = 0 termination OFF;
 = 1 termination ON.
- TERM SW:** Allows to select the termination mode
 = 0 termination via dip-switch;
 = 1 termination via software.
- EMPTY EVENT:** Allows to choose if writing the Global Header and the Global Trailer when there are no data from the TDCs.
 =0 when there are no data, nothing is written in the Output Buffer (default).
 =1 when there are no data, the Global Header and the Trailer are anyway written in the Output Buffer.
- ALIGN 64:** Allows to add a 32 bit dummy-word (marked as not valid datum) to an event which is made up of an odd number of words during BLT32 and CBLT32 data readout. In fact some 64 bit CPU's cut off the last 32 bit word of a

transferred block if the number of words composing such block is odd, so it is necessary to add a dummy word (which will be then eventually removed via software) in order to avoid data loss. It is used in BLT32 and CBLT32.

= 0 no dummy word added (default);
= 1 dummy word added when the number of words is odd.

COMPENSATION ENABLE : 0 = compensation of the INL disabled
1 = compensation of the INL enabled (default)
(see § 2.5)

TEST FIFO ENABLE: 0 = Output Buffer test mode disabled (default)
1 = Output Buffer test mode enabled (see § 6.22)

READ COMPENSATION SRAM ENABLE: 0 = the sram where the compensation table is written cannot be readout (default)
1 = the sram where the compensation table is written can be readout (see § 4.8.5)

EVENT FIFO ENABLE: if the event FIFO is enabled when an event is written in the buffer, the FPGA writes in its internal FIFO a 32 bit word containing the event counter on 16 bit and the event number of words:
0 = event FIFO disabled (default)
1 = event FIFO enabled (see § 6.18)

EXTD. TRIGGER TIME TAG ENABLE: 0 = writing of the Extended Trigger Time Tag in an event disabled (default)
1 = writing of the Extended Trigger Time Tag in an event enabled (see § 6.2.1)

NOTE: Control BUS termination

The 110 Ohm terminations of the Control Bus are realised with electronic switches. When a reset is performed such switches are enabled through a mechanical switch on the board (TERM_SW = 0): if this switch is on the TERM ON position the Control Bus is terminated, if it is on TERM OFF the Control Bus is not terminated. In this case the TERM bit of the CONTROL register is meaningless.

If the TERM_SW bit of the CONTROL register is set to 1 the electronic switches can be enabled via software, by setting the TERM bit of the same register.

In both cases the termination status can be read out in the STATUS register (bit TERM_ON).

Setting to 0 the TERM_SW bit the termination takes place via mechanical switch.

The last module in a chain controlled via the front panel CONTROL connector must have these terminations ON, while all the others must have them OFF.

6.4. Status Register

(Base + 0x1002, read only, D16)

This register contains information on the status of the module. TERM ON refers to the terminations of the CONTROL bus lines: The insertion or removal of the terminations is performed either via hardware or via software (see § 3.6.1 and § 6.3).

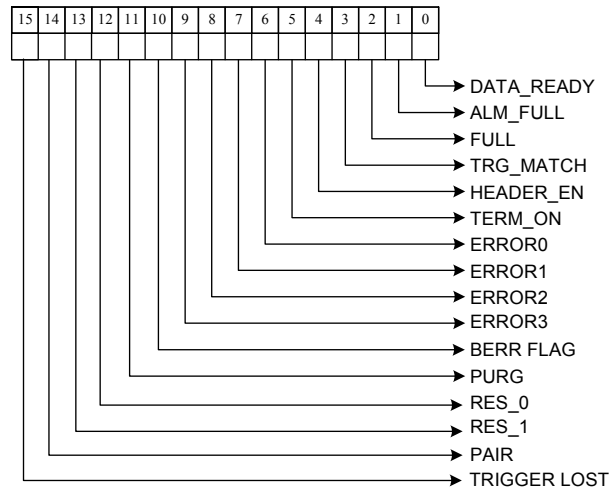

Fig. 6.10: Status Register

- DREADY:** Indicates that there are data (at least 1 event in trigger matching mode) in the Output Buffer.
 = 0 No Data Ready;
 = 1 Event Ready (Trigger Matching); Data Ready (Continuous Storage).
- ALMOST FULL:** Indicates whether the Almost Full Level has been met or not
 = 0 less words than the Almost Full Level number of words in the Output Buffer;
 = 1 There are at least Almost Full Level words in the Output Buffer.
- FULL:** Indicates that the Output Buffer is full. The Output Buffer is flagged as FULL when it contains 32k words (Output Buffer size) minus 33 words.
 = 0 The Output Buffer is not FULL;
 = 1 The Output Buffer is FULL.
- TRG MATCH:** Indicates the selected operating mode
 = 1 trigger matching mode;
 = 0 continuous storage mode.
- HEADER EN:** Indicates the enabling of the TDCs' Header and TRAILER
 = 0 TDCs' Header and TRAILER disabled;
 = 1 TDCs' Header and TRAILER enabled.
- TERM ON:** Termination ON/OFF bit
 = 0 all Control Bus Terminations are OFF;
 = 1 all Control Bus Terminations are ON.

ERROR i:	Indicates an error in the TDCi (V1190 A: i = 0÷3; V1190 B: i = 0÷1) = 0 TDC i operated properly. = 1 TDC i error has occurred.
BERR FLAG:	= 0 no Bus Error has occurred = 1 a Bus Error has occurred (this bit is re-set after a status register read out)
PURGED:	= 0 board not purged = 1 board purged: a) the board has no data; b) if a CBLT is taking place, the board has already transferred all its data: in this case, the board leaves purged status as soon as the CBLT ends and the last board in the chain asserts BERR)
RES[1,0]:	00 = 800ps 01 = 200ps 10 = 100ps
PAIR MODE:	= 0 module not in pair mode = 1 module in pair mode
TRIGGER LOST:	= 0 all trigger were sent to the TDCs = 1 one trigger at least was not sent to the TDCs (this bit is reset after a status register read out)

6.5. ADER 32 Register (only for VX1190 A/B)

(Base Address + 0x1004, read/write, D16)

This register contains the A31...A24 bits of the address of the module: it can be set via VME for a relocation of the Base Address of the module. The register content is the following:

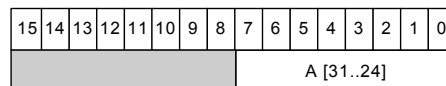

Fig. 6.11: ADER 32 Register

6.6. ADER 24 Register (only for VX1190 A/B)

(Base Address + 0x1006 read/write, D16)

This register contains the A23...A16 bits of the address of the module: it can be set via VME for a relocation of the Base Address of the module. The register content is the following:

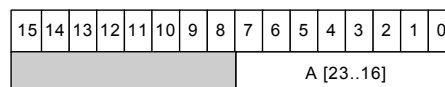

Fig. 6.12: ADER 24 Register

6.7. Enable Ader Register (only for VX1190 A/B)

(Base Address + 0x1008, write only, D16)

This Register allows to activate the Base Address relocation. The GEO address is not influenced by the relocation.

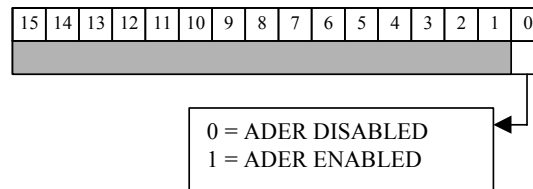

Fig. 6.13: Enable ADER Register

ENABLE ADDRESS: Select Address bit.
 = 0 base address is selected via Rotary Switch (default);
 = 1 base address is selected via High and Low ADER registers.

N.B.: this register determines the base address variation of the module. Any VME accesses to the previous board's base address does not work.

6.8. Interrupt Level Register

(Base Address + 0x100A, read/write, D16)

The 3 LSB of this register contain the value of the interrupt level (Bits 3 to 15 are meaningless). Default setting is 0x0. In this case interrupt generation is disabled.

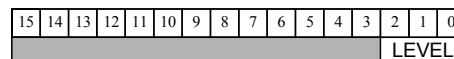

Fig. 6.14: Interrupt Level Register

6.9. Interrupt Vector Register

(Base Address + 0x100C, read/write, D16)

This register contains the STATUS/ID that the V1190 A/B places on the VME data bus during the Interrupt Acknowledge cycle (Bits 8 to 15 are meaningless). Default setting is 0xDD.

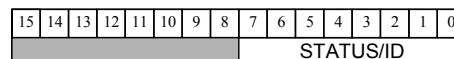

Fig. 6.15: Interrupt Vector Register

6.10. GEO Address Register

(Base Address + 0x100E, read/write, D16)

The register content is the following:

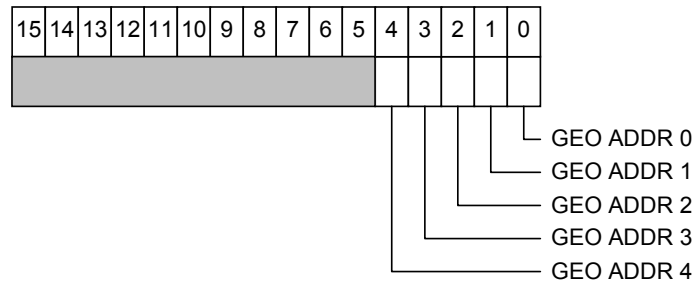

Fig. 6.16: Geographical address register

GEO [4...0] corresponds to A23...A19 in the address space of the CR/CSR area.

The bits of the GEO Address register are set to 1 by default. It is up to the User to write the correct GEO address of the module in this register before CBLT operation so that the GEO address will be contained in the HEADER and the TRAILER words for data identification.

N.B.: The VME std. versions (V1190 A/B) use this register ONLY for data identification during CBLT operation (see § 4.4.3).

6.11. MCST Base Address Register

(Base Address + 0x1010, read/write, D16)

This register contains the most significant bits of the MCST/CBLT address of the module set via VME, i.e. the address used in MCST/CBLT operations. Refer to § 4.4.3 for details about MCST/CBLT addressing mode.

The register content is the following:

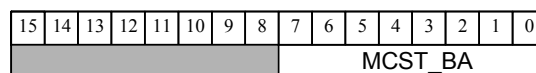

Fig. 6.17: MCST/CBLT address register

Default setting (i.e. at power ON or after hardware reset) is 0xAA; this address should not be set via rotary switches on other boards in the crate.

6.12. MCST/CBLT Control Register

(Base Address + 0x1012, read/write, D16)

This register allows performing the MCST/CBLT settings of the module (see § 4.4.3); the status of the boards according to the bits' value is the following:

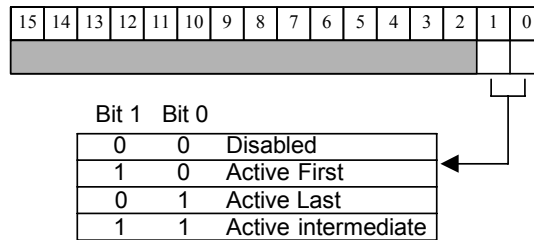

Fig. 6.18: MCST/CBLT Control Register

6.13. Module Reset Register

(Base Address + 0x1014 write only, D16)

A dummy access to this register allows to generate a single shot RESET of the module (see also § 4.8).

6.14. Software Clear Register

(Base Address + 0x1016 write only, D16)

A write access to this location causes the following:

- the TDCs are cleared;
- the Output Buffer is cleared;
- the Event counter is set to 0;
- TDC Global Reset

See also § 4.8.

6.15. Software Event Reset Register

(Base Address + 0x1018 write only, D16)

A write access to this location allows to perform a TDCs' software event reset (see also § 4.8).

6.16. Software Trigger Register

(Base Address + 0x101A write only, D16)

A write access to this location generates a trigger via software.

6.17. Event Counter Register

(Base Address + 0x101C, read only, D32)

This register contains the number of occurred triggers and thus of acquired events since the latest module's reset/clear; the counter works in trigger Matching Mode only.

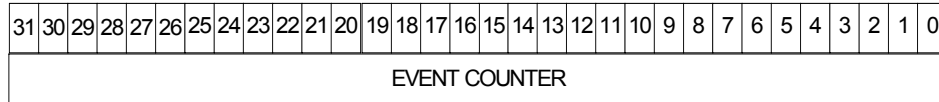

Fig. 6.19: Trigger Counter Register

6.18. Event Stored register

(Base Address + 0x1020, read only, D16)

This register contains the number of events currently stored in the Output Buffer.



Fig. 6.20: Event Stored Register

6.19. Almost Full Level Register

(Base Address + 0x1022, read/write, D16)

This Register allows the User to set the Almost Full Level of the Output Buffer. When the Output Buffer contains a number of words at least equal to the Almost Full Level, then an Interrupt Request (IRQ) is generated (if enabled) and the corresponding bit in the Status Register is set.

FIFO depth:	min AFL:	max AFL:
32Kwords	1	32735

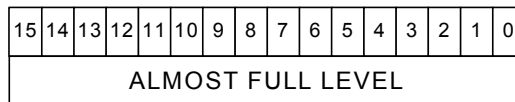

Fig. 6.21: Almost Full Level Register

The default Almost Full Level is 64 words. This Register can be accessed in D16 mode. MCST access is also allowed.

6.20. BLT Event Number Register

(Base Address + 0x1024, read/write, D16)

This register contains the number **Ne** of complete events which is desirable to transfer via BLT. The number of events must be written in a 8 bit word. The Register's default setting is 0, which means that the Event Aligned BLT is disabled. This Register must be accessed in D16 mode. MCST access is also allowed (see § 4.6).

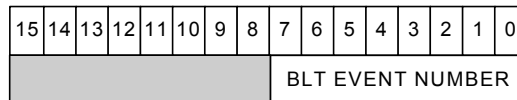

Fig. 6.22: BLT Event Number Register

6.21. Firmware Revision Register

(Base Address + 0x1026, read only, D16)

This register contains the firmware revision number coded on 8 bit. For example the REV. 1.2 would feature:

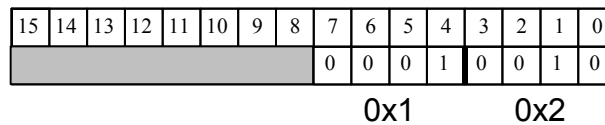

Fig. 6.23 Firmware Revision Register

6.22. Testreg Register

(Base Address + 0x1028, read/write only, D32)

If TEST_FIFO is enabled in the Control Register (see § 6.3), whenever a 32 bit word is written into the Testreg, such word is loaded into the Output Buffer (and it is ready to be readout). When TEST_FIFO is enabled, eventual data from the TDCs are not loaded into the Output Buffer.

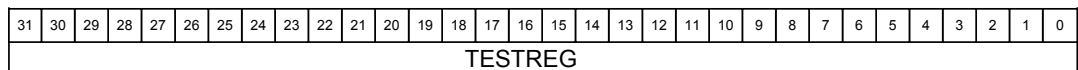

Fig. 6.24: Testreg Register

6.23. OUT_PROG Control Register

(Base Address + 0x102C, read/write, D16)

This register allows to set the function of the OUT_PROG ECL output on the control connector in the following way:

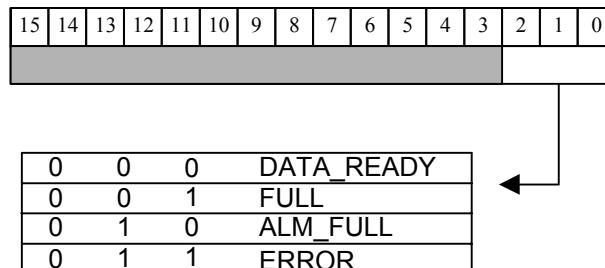

Fig. 6.25: Out_Prog Register

The OUT_PROG status can be monitored through the relevant bits of the Status Register. See § 6.4 for details about DATA_READY, FULL, ALM_FULL and ERROR.

6.24. Micro Register

(Base Address + 0x102E, read/write, D16)

This register is used to send instructions to the microcontroller via 16-bit OPCODE setup words. The usage of this register is fully described in § 5.1.

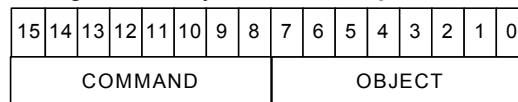

Fig. 6.26: Micro Register

6.25. Micro Handshake Register

(Base Address + 0x1030, read only, D16)

The Micro Handshake Register is used for the Handshake Protocol between the VME and the microcontroller. It uses only 2 bits: READ OK and WRITE OK.

All read and write operations with the Micro Register can be performed, respectively, when the bit RO or WO is set (see also § 5.1).

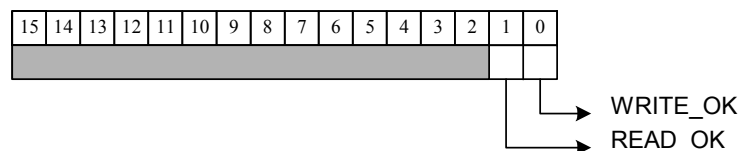

Fig. 6.27: Micro Handshake register

6.26. Dummy32 Register

(Base Address + 0x1200, D32, read/write)

This register allows to perform 32 bit test accesses for test purposes.

6.27. Dummy16 Register

(Base Address + 0x1204, D16, read/write)

This register allows to perform 16 bit test accesses for test purposes.

6.28. Select Flash Register

(Base Address + 0x1032, read/write, D16)

This register's LSB corresponds to the chip select (/CS) of the Flash serial memory (where are loaded the two firmware versions of the board, the configuration ROM and the compensation tables; see Appendix A).

The Flash memory is selected when the /CS bit is low. When the device is not selected, data will not be accepted on the input pin, and the output pin will remain in a high-impedance state. A high-to-low transition on the /CS bit is required to start an operation on the flash and a low-to-high transition on the CS pin is required to end an operation.

SELECT FLASH = 0 Flash memory selected
 = 1 Flash memory not selected (default).

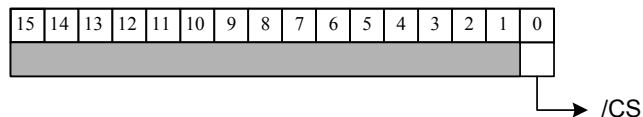

Fig. 6.28: Select Flash register

6.29. Flash Memory

(Base Address + 0x1034, read/write, D16)

The module features a Flash serial memory (2048 pages x 264 bytes; 256 bytes per page actually used). A write access to this register is converted by the FPGA into a serial 8 bit writing. Instead, a read access causes a 8 bit serial readout from the Flash.

The content of the Flash, as well as the read/write accesses, are described in more detail in Appendix A.

6.30. Compensation Sram Page Register

(Base Address + 0x1036, read/write, D16)

The 8 LSBs of this register are referred to the page address of the COMPENSATION SRAM. The COMPENSATION SRAM can be readout for test purposes: the READ COMPENSATION SRAM ENABLE bit of the Control Register must be set for this purpose. The Sram page set in the COMPENSATION SRAM PAGE Register (default

PAGE 0) can be readout at the addresses listed in the COMPENSATION SRAM section (256 pages X 256 bytes); see § 6.34.

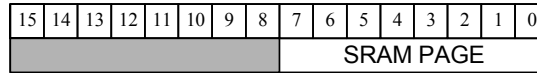

Fig. 6.29: Compensation Sram Page register

See Appendix A for more details.

6.31. Event FIFO

(Base Address + 0x1038, read only, D32)

The Event FIFO is introduced in order to help the event readout from the Output Buffer, since the size of the events is unknown a priori: if the event FIFO is enabled (Bit EVENT FIFO ENABLE of Control register = 1) every time an event is written in the Output Buffer, a 32 bit word is written into a 1 kword deep FIFO housed in the module's FPGA: such word includes the Event Counter on bits [31..16] and the event's words number:

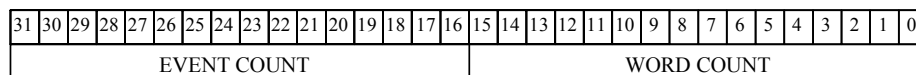

Fig. 6.30: Event FIFO register

Refer to § 4.6.7 for details about data readout with Event FIFO enabled.

6.32. Event FIFO Stored Register

(Base Address + 0x103C, read only, D16)

This register contains the number of word currently stored in the Event FIFO (if enabled).



Fig. 6.31: Event FIFO Stored register

If the Output Buffer readout with event FIFO enabled takes place correctly, as shown in § 4.6.7, this register's content corresponds to the number of events correctly stored in the Output Buffer (see § 6.18)

6.33. Event FIFO Status Register

(Base Address + 0x103E, read only, D16)

This register contains information on the status of the EVENT FIFO.

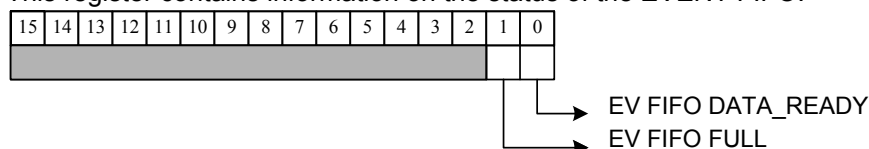

Fig. 6.32: Event FIFO Status register

EV FIFO DREADY: Indicates that there are data in the Event FIFO.
 = 0 No Data Ready in the Event FIFO;
 = 1 Event FIFO Data ready.

FULL: Indicates that the Event FIFO is full. (contains 1024 X 32 bit words)
 = 0 The Event FIFO is not FULL;
 = 1 The Event FIFO is FULL.

As shown in § 4.6.7, if the event FIFO is enabled, the board is Full (Bit FULL of Status register = 1) whether the Output Buffer or the Event FIFO is Full.

6.34. Compensation Sram

(Base Address + 0x8000 ÷ 0x81FE, read only, D16)

If the READ COMPENSATION SRAM ENABLE bit of Control register is set to one, the page of the COMPENSATION SRAM, selected via the COMPENSATION SRAM PAGE register, can be read at Base Address + 0x8000 ÷ 0x81FE.

Fig. 6.30 shows the COMPENSATION SRAM content: since the TDCs NLI curve is periodical (TNLI = TTDCLOCK = 25 ns), the Lock Up table covers only one clock period (i.e. 256 entries when LSB=100ps, 128 entries when LSB=200ps).

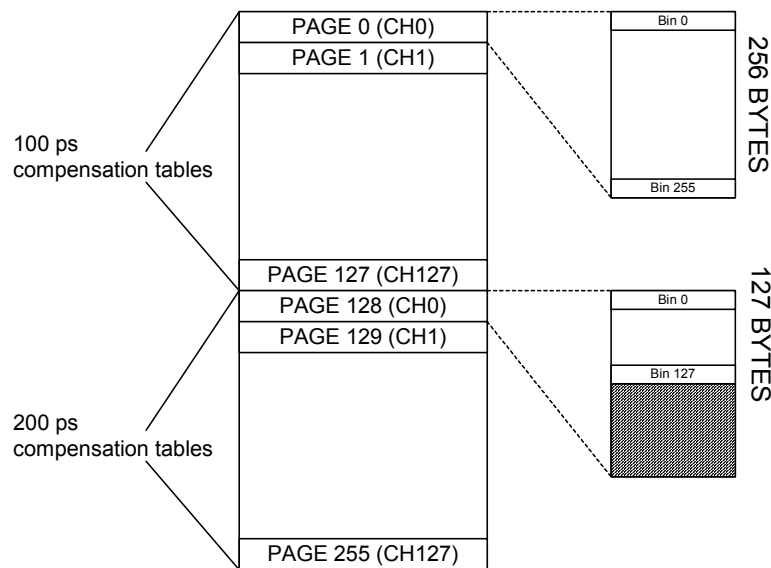

Fig. 6.33: COMPENSATION SRAM Architecture

See Appendix A for further details.

APPENDIX A: FLASH memory accesses

The module houses a serial FLASH where the NLI compensation tables are memorised (see § 2.5); moreover the FLASH includes some board information (configuration ROM, see also § 6.1.1) and the two Firmware versions of the FPGA (see § 4.9). Fig. A.1 shows the FLASH content.

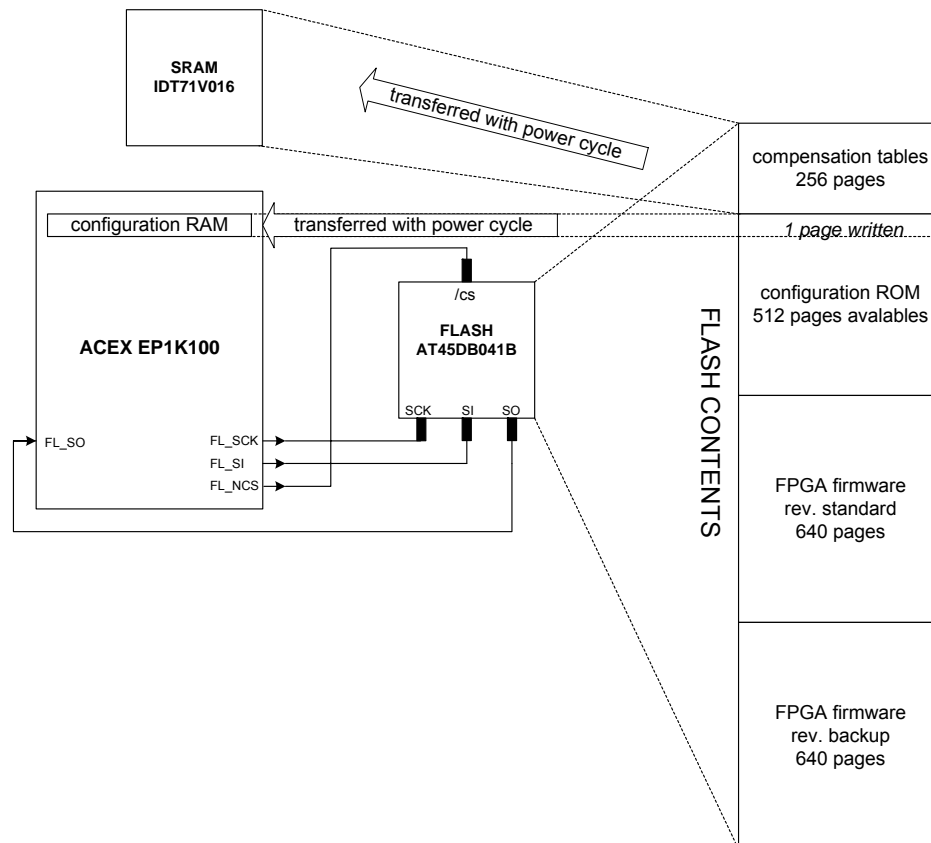

Fig. A.1: FLASH Architecture

At Power On:

- The microcontroller programs the FPGA with the Firmware revision selected via the J13 Jumper (default position: STD).
- The FPGA reads the NLI compensation tables (256 pages X 256 bytes) and loads them in a on board SRAM (see § 6.34). The COMPENSATION SRAM can be readout via VME for test purposes.
- Then the FPGA reads one page containing the Configuration ROM and writes it in a RAM inside the FPGA itself, which can be readout directly via VME (see § 6.1.1).

During TDC data acquisition, the FPGA corrects them through the LUT memorised in the Compensation SRAM (if the compensation is enabled: compensation enable bit of CONTROL register = 1).

If the User wishes either to update the FPGA firmware or to load new compensation tables, the FLASH can be written/read via VME.

N.B.: FLASH accesses are suggested only to experienced Users.

Two VME read/write procedures referred to a page of the FLASH are shown in the following:

```

/*****/
/* Company:          CAEN SpA - Viareggio - Italy          */
/* Model:            V1190 - 128 Channel Multihit TDC      */
/*****/

/*****/
/*          FLASH memory accesses addresses & opcodes          */
/*****/

#define MAIN_MEM_PAGE_READ          0x00D2
#define MAIN_MEM_PAGE_PROG_TH_BUF1  0x0082
#define PAGE_ERASE                   0x0081

#define SEL_FLASH                    0x1032
#define FLASH_MEM                    0x1034

unsigned long v1190_base_address; /* base address of the board */

/*****/
/*          WRITE_FLASH_PAGE          */
/*-----*/
/* parameters      :   pagenum: number of page to write      */
/*                  page   : page to write                    */
/*-----*/
/* write a flash page          */
/*****/

void write_flash_page(unsigned char* page, unsigned long pagenum)
{
    unsigned long  flash_addr,data;
    unsigned char  addr0,addr1,addr2;
    unsigned short i;

    flash_addr = pagenum<<9;

```

```
addr0 = (unsigned char) flash_addr;
addr1 = (unsigned char)(flash_addr>>8);
addr2 = (unsigned char)(flash_addr>>16);

/* enable flash (NCS = 0) */
data = 0;
vme_write(v1190_base_address + SEL_FLASH, data, A32, D16);

/* write opcode */
data = MAIN_MEM_PAGE_PROG_TH_BUF1;
vme_write(v1190_base_address + FLASH_MEM, data, A32, D16);

/* write address */
data = addr2;
vme_write(v1190_base_address + FLASH_MEM, data, A32, D16);
data = addr1;
vme_write(v1190_base_address + FLASH_MEM, data, A32, D16);
data = addr0;
vme_write(v1190_base_address + FLASH_MEM, data, A32, D16);

/* write flash page (264 bytes for page, 256 used) */
for (i=0; i<264; i++)
{
    data = page[i];
    vme_write(v1190_base_address + FLASH_MEM, data, A32, D16);
}

/* disable flash (NCS = 1) */
data = 1;
vme_write(v1190_base_address + SEL_FLASH, data, A32, D16);

/* wait 20ms (max time required by the flash to complete the writing) */
delay(20);
}
```

```
/*-----*/
/*          READ_FLASH_PAGE          */
/*-----*/
/* parameters      :      pagenum: number of page to read      */
/*          page      :      read page          */
/*-----*/
/* read a flash page          */
/*-----*/
void read_flash_page(unsigned char* page, unsigned long pagenum)
{
    unsigned long  flash_addr,data;
    unsigned char  addr0,addr1,addr2;
    unsigned short i;

    flash_addr = pagenum<<9;
    addr0 = (unsigned char)flash_addr;
    addr1 = (unsigned char)(flash_addr>>8);
    addr2 = (unsigned char)(flash_addr>>16);

    /* enable flash (NCS = 0) */
    data = 0;
    vme_write(v1190_base_address + SEL_FLASH, data, A32, D16);

    /* write opcode */
    data = MAIN_MEM_PAGE_READ;
    vme_write(v1190_base_address + FLASH_MEM, data, A32, D16);

    /* write address */
    data = addr2;
    vme_write(v1190_base_address + FLASH_MEM, data, A32, D16);
    data = addr1;
    vme_write(v1190_base_address + FLASH_MEM, data, A32, D16);
    data = addr0;
    vme_write(v1190_base_address + FLASH_MEM, data, A32, D16);

    /* additional don't care bytes */
}
```



```
data = 0;
for (i=0; i<4; i++)
{
    vme_write(v1190_base_address + FLASH_MEM, data, A32, D16);
}

/* read flash page (264 bytes for page, 256 used) */
for (i=0; i<264; i++)
{
    vme_read_dt(v1190_base_address + FLASH_MEM, &data, A32, D32)
    page[i] = data;
}

/* disable flash (NCS = 1) */
data = 1;
vme_write(v1190_base_address + SEL_FLASH, data, A32, D16);
}
```

APPENDIX B: Default Set Up Scan Path

The following table reports the complete V1190 default setup scan path. For further information on the parameters refer to **Errore. L'origine riferimento non è stata trovata..**

Table B.2: Default Set Up Scan Path

Parameter	bit	Value (binary)	Scan_path_word
test_select	3:0	1110	
enable_error_mark	4	1	
enable_error_bypass	5	0	
enable_error	16:6	1111111111	[0] 0xFFDE
readout_single_cycle_speed	19:17	00	
serial_delay	23:20	0000	
strobe_select	25:24	00	
readout_speed_select	26	0	
token_delay	30:27	0000	
enable_local_trailer	31	1	[1] 0x8001
enable_local_header	32	1	
enable_global_trailer	33	0	
enable_global_header	34	0	
keep_token	35	1	
master	36	0	
enable_bytewise	37	0	
enable_serial	38	0	
enable_jtag_readout	39	0	
tdc_id	43:40	00-01-10-11	
select_bypass_inputs	44	0	
readout_fifo_size	47:45	111	[2] 0xE009 ⁽¹⁾
reject_counter_offset ⁽²⁾	59:48	1111110100001	
search_window ⁽²⁾	71:60	000000011011	[3] 0xBFD1
match_window ⁽²⁾	83:72	000000010011	[4] 0x1301
leading_resolution ⁽³⁾	86:84	000	
fixed_pattern	114:87	0 (all)	[5-6] 0x0000
enable_fixed_pattern	115	0	

max_event_size	119:116	1001	
reject_readout_fifo_full	120	1	
enable_readout_occupancy	121	0	
enable_readout_separator	122	0	
enable_overflow_detect	123	1	
enable_relative	124	0	
enable_automatic_reject	125	1	
event_count_offset	137:126	0 (all)	[7] 0x2990
trigger_count_offset ⁽²⁾	149:138	111111010101	[8] 0x5400
enable_set_counters_on_bunch_reset	150	1	
enable_master_reset_code	151	0	
enable_master_reset_on_event_reset	152	0	
enable_reset_channel_buffer_when_separator	153	0	
enable_separator_on_event_reset	154	0	
enable_separator_on_bunch_reset	155	0	
enable_direct_event_reset	156	1	
enable_direct_bunch_reset	157	1	
enable_direct_trigger	158	1	
Offset (31:0)	446:159	0 (all)	[9] 0x707F
coarse_count_offset	458:447	0	[10-27] 0x0000
dll_tap_adjust	554:459	dll_tap_adj[0-3]=0	[28] 0x0000
“		dll_tap_adj[4-7]=1	[29] 0x2480
“		dll_tap_adj[8-11]=2	[30] 0xA491
“		dll_tap_adj[12-15]=3	
“		dll_tap_adj[16-19]=4	[31] 0x236D
“		dll_tap_adj[20-23]=5	
“		dll_tap_adj[24-27]=6	[32] 0xB6C9
“		dll_tap_adj[28-31]=7	[33] 0xEDB5
rc_adjust	569:555	00001111111111	[34] 0xFFFF
low_power_mode (rc_adjust bit15)	570	1	
width_select	574:571	0000	
vernier_offset	579:575	0 (all)	[35] 0x041F
dll_control	584:580	0001	
dead_time	585:584	00	

test_invert	586	0	
test_mode	587	0	
enable_trailing	588	0	
enable_leading	589	1	
mode_rc_compression	590	0	
mode_rc	591	0	[36] 0x2010
dll_mode ⁽³⁾	593:592	10	
pll_control	601:594	00000100	
serial_clock_delay	605:602	0000	
io_clock_delay	609:606	0000	[37] 0x0012
core_clock_delay	613:610	0000	
dll_clock_delay	617:614	0000	
serial_clock_source	619:618	00	
io_clock_source	621:620	00	
core_clock_source	623:622	00	[38] 0x0000
dll_clock_source ⁽³⁾	626:624	011	
roll_over	638:627	0xFFFF	
enable_matching	639	0	[39] 0x7FFB
enable_pair	640	0	
enable_ttl_serial	641	1	
enable_ttl_control	642	1	
enable_ttl_reset	643	1	
enable_ttl_clock	644	0	
enable_ttl_hit	645	0	
parity	646	-	[40] 0x0E or 0x4E

(1): 0xE009, 0xE109, 0xE209 or 0xE309 (as a function of the TDC-ID)

(2) TRIGGER MATCHING PARAMETERS (see § 2.4)

The selected parameters are transferred to the HPTDC chips by the microcontroller.

The default configuration is the following :

Trigger Match windows = 500 ns;

Extra search_window = 200 ns;

Window offset = -1 µs;

Reject margin = 100 ns;

Such values are “translated” by the microcontroller as follows:

match_window = (500/25)-1 = 19 = 0x13;

extra_search_window = match_windows + 8 = 27 = 0x1B;

latency = -window offset=(1000/25) + 3 = 43 [the offset "3" is for compensating an internal delay]

trigger_couter_offset = FFF(roll_over)-latency+1= 0xFD5;

reject_latency = latency+4 = 47;

reject_couter_offset = FFF(roll_over)-reject_latency+1= 0xFD1

(3) DLL clock e resolution

The resolution values are set through several interconnected fields:

Dll clock	dll_clock_source	dll_mode	leading_resolution
40 MHz PLL	001	00	001 (200 psec)
160 MHz	010	01	001 (200 psec)
320 MHz	011	10	000 (100 psec)

References

- [1] G. Bianchetti et al., "Specification for VMEbus CRATE Type V430", CERN-EP, January 1990.
- [2] -VME64 extensions draft standard, Vita 1.1-199x, draft 1.8, June 13,1997.
- [3] -VMEBus for Physics Application, Recommendations & Guidelines, Vita23-199x, draft 1.0, 22 May 1997.
- [4] J. Christiansen, "HPTDC Version 2.0", September 2001