



# MPOD HV& LV Power Supply System

---

## Technical Manual



## **General Remarks**

The only purpose of this manual is a description of the product. It must not be interpreted as a declaration of conformity for this product including the product and software.

**W-IE-Ne-R** revises this product and manual without notice. Differences of the description in manual and product are possible.

**W-IE-Ne-R** excludes completely any liability for loss of profits, loss of business, loss of use or data, interrupt of business, or for indirect, special incidental, or consequential damages of any kind, even if **W-IE-Ne-R** has been advises of the possibility of such damages arising from any defect or error in this manual or product.

Any use of the product which may influence health of human beings requires the express written permission of **W-IE-Ne-R**.

Products mentioned in this manual are mentioned for identification purposes only. Product names appearing in this manual may or may not be registered trademarks or copyrights of their respective companies.

No part of this product, including the product and the software may be reproduced, transmitted, transcribed, stored in a retrieval system, or translated into any language in any form by any means with the express written permission of **W-IE-Ne-R**.

## **Control Cabinet**

In the context of this user manual, the control cabinet must fulfill the requirements on fire-protective enclosures according to EN 60950 / IEC 60950 / UL 60950.

All devices are intended for operation in control cabinets or in closed areas. The LAN connection and all wire connections between the different system parts must be done via shielded cable with conductive connector shells, which are fixed with screws.

Furthermore, an additional fire-protective enclosure is required which must not affect proper air circulation.

## Mains Voltage and Connection

The Power supplies are equipped with a “World”- mains input (rated voltage range: 100-240 VAC, frequency: 50-60 Hz, rated current: 16 A). Before connecting to the mains please double-check correspondence.

Mains input connection at the power supply side is done with a 3-pin HIRSCHMANN connector or power terminals. There is no main fuse inside. A circuit breaker for overcurrent protection 16A, type B or C (EN / IEC 60898, VDE 0641), has to be installed externally.

Before disconnection the HIRSCHMANN connector, the power supply should be switched into standby state. (Use the ON/OFF-Switch of the front pannel of the MPOD system)

Hirschmann.	Signal	Description	Color of the Wire
Pin 1	L	Phase	black or brown
Pin 2	N	Return, Neutral	blue
Pin 3		not connected	
Earth	PE	Protective Earth	green/yellow

## Connection to Earth

### Safety

After connecting the Power box to the mains, the mains input module is powered permanently. Filter and storage capacitors of the power factor correction module are charged with about **400VDC**. Any DC-On-Signal as well as a power switch at control board (if any installed) operates as a low voltage DC on/off switch only and not as a mains breaker. **Therefore it becomes dangerous if the box cover is open. In this case a lot of components on high voltage potential get touchable!**

**Before starting any kind of work inside the power box remove the unit from mains and wait a couple of minutes with your activities! Discharge the primary DC Filter-capacitors by use of a well isolated 22 ohm 10W resistor.**

**We recommend in case of any malfunction to send the power box to Wiener or to one of our representative for service**



**The backplane is connected to 385 V DC voltage. So never touch the backplane or its connectors!**

**The HV-Modules produce very high voltage which may be mortal danger if handled improperly. Please read the separate manuals of the HV modules for detailed information!**



## Declaration of Conformity

Low Voltage Directive 73/23/EEC and EMC Directive Art. 10.1 of 89/336/EEC

# W-IE-NE-R

Plein & Baus GmbH

---

declare under our own responsibility that the product

## MPOD Power Supply System

Items: 0MPV.xxxx, 0BP0.9003, 0316.0070, 0R00.0002

is in accordance with the following standards or standardized documents:

- |    |  |   |
|----|--|---|
| 1. | <b>EN 60 950-1:2001</b><br>+ Corr:2004-09  | Niederspannungsrichtlinie [low voltage directive]   |
| 2. | <b>EN 61 000-6-3:2001</b><br>EN 55 022:1998<br>+ Corr:2001 + A1:2000 Kl. B<br>EN 55 022:1998<br>+ Corr:2001 + A1:2000 Kl. B<br>EN 61 000-3-2:2001<br>EN 61 000-3-3:1995 +Corr:1997 +A1:2001  | Störaussendung EMA [RF emission]<br>Störspannung [conducted noise]<br>Störfeldstärke [radiated noise]<br>Oberschwingungen [harmonics]<br>Spannungsschwankungen [flicker]                              |
| 3. | <b>EN 61 000-6-2:2001</b><br>EN 61 000-4-6:1996 + A1:2001<br>EN 61 000-4-3:1996 + A1:1998 + A2:2001<br><br>EN 61 000-4-4:1995 + A1:2001<br>EN 61 000-4-5:1995 + A1:2001<br>EN 61 000-4-11:1994 + A1:2000<br><br>EN 61 000-4-2:1995 + A1:1998 + A2:2001 | <b>Störfestigkeit EMB [immunity]</b><br>HF-Einströmung [injected HF currents]<br>HF-Felder [radiated HF fields] incl. "900MHz"<br>Burst<br>Surge<br>Spannungs-Variationen [voltage variations]<br>ESD |

### Conditions:

---

This unit is not a final product and is foreseen for use inside a closed cabinet. The supplying of loads over long distances (>3m) needs possibly additional RF rejection hardware to get in conformity of the definition.

Name and signature of authorized person

Place and Date

Manfred Plein

Techn. Director  
April 2008

# Contents

<b>Declaration of Conformity.....</b>	<b>iii</b>
1 General Information.....	1
<b>1.1 Mpod Features .....</b>	<b>1</b>
2 LV Modules.....	2
<b>2.1 Odering Numbers.....</b>	<b>2</b>
<b>2.2 Sense &amp; Control Connector Pin Assignment.....</b>	<b>3</b>
<b>2.3 Power Connector Pin Assignment.....</b>	<b>4</b>
3 HV Modules .....	4
4 Mpod Controller.....	6
<b>4.1 Odering Numbers.....</b>	<b>6</b>
<b>4.2 Software Setup.....</b>	<b>6</b>
<b>4.3 Web Browser.....</b>	<b>9</b>
5 Power Supply.....	10
<b>5.1 Odering Numbers.....</b>	<b>10</b>
6 Mpod Crates.....	11
<b>6.1 Odering Numbers.....</b>	<b>11</b>
7 Power Box Data Sheet.....	12
8 Primary Powe Supply Data Sheet.....	15
9 MPOD Controller Data Sheet.....	16

**Figures**

**Tables**



# 1 General Information



Mpod LX crate with mixed low and high voltage modules

## 1.1 Mpod Features

Mpod is a mainframe for multi-channel high voltage (HV) and low voltage (LV) power supply modules. A unique flexibility is given by outfitting the MPOD crate with either the LV or HV backplane only or with both to allow combined use of LV and HV modules. The full size Mpod crate has 10 slots for power modules which provides a high number of output channels. Its modular design makes the customer able to easily replace the fan tray, the controller, the primary power supply or the optional air filter.

- 10 module slots for up to 80 LV channels / up to 320 HV channels
- 8U high for bottom cooling air intake, optional 9U high as desktop or front / side intake with dust filter
- Modules and controller outputs can be placed either at front or rear side (picture above shows front side)
- LV: 4/8 channels (0- 8/16/30/60V, 50W / channel, special modules up to 200V), floating
- HV: 320/160/80 channels (0- 2,5/4/6kV/8kV), channel- or module wise floating or common ground
- Low noise and ripple
- Individually controlled output channels (voltage and current), programmable warning and trip levels
- MPOD Controller with Ethernet (TCP/IP) / CANbus / USB Combi-interface, Interlock

- Ethernet port with integrated Web server, programmable with SNMP protocol via TCP/IP, OPC Server
- CE conform EN 50 081/82 part 1 (EN 50 022 B)
- safety in accordance with EN 60 950
- Sinusoidal mains current EN 61000-3-2

## 1.2 Mpod Crate - standard types

The following crate types are standardized configurations with 8U high chassis. Optionally a filter frame is available with bottom or front air inlet which increases the height to 9U.

Other configurations and mixed system with part of the crate outfitted with PCI or VME backplanes are available on request.

Type	Slots	Remote control interface	Local control / Backplane display	HV	HV power	Output Position
<b>Mpod EC</b>	10	Ethernet, CAN, USB	-	HV/LV	600W	front
<b>Mpod EC-R</b>	10	Ethernet, CAN, USB	-	HV/LV	600W	rear
<b>Mpod LX</b>	10	Ethernet, CAN, USB	Yes, LCD	HV/LV	600W	front
<b>Mpod LX-R</b>	10	Ethernet, CAN, USB	Yes, LCD	HV/LV	600W	rear
<b>Mpod EC-LV</b>	10	Ethernet, CAN, USB	-	LV	-	front
<b>Mpod EC-LV-R</b>	10	Ethernet, CAN, USB	-	LV	-	rear
<b>Mpod EC-HV</b>	10	Ethernet, CAN, USB	-	HV	600W	front
<b>Mpod EC-HV-R</b>	10	Ethernet, CAN, USB	-	HV	600W	rear
<b>Mpod 2H</b>	10	Ethernet, CAN, USB	-	HV	1200W	front
<b>Mpod 2H-R</b>	10	Ethernet, CAN, USB	-	HV	1200W	rear
<b>Mpod 2H-LX</b>	10	Ethernet, CAN, USB	Yes, LCD	HV	1200W	front
<b>Mpod 2H-LX-R</b>	10	Ethernet, CAN, USB	Yes, LCD	HV	1200W	rear

(CAN-bus for HV modules only, disabling Ethernet communication may be necessary for ISEG CAN-HV control software)

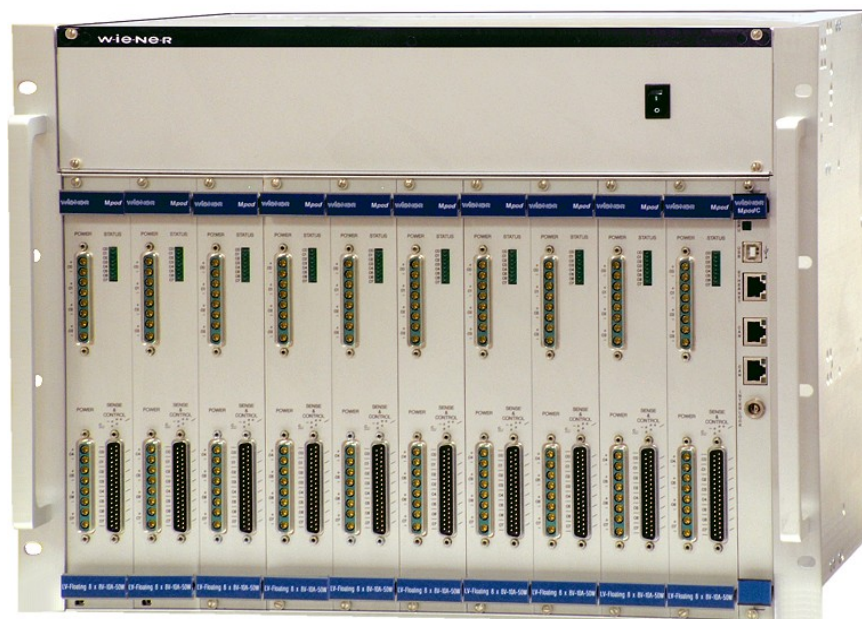

Mpod LC-LV crate for low voltage modules

### 1.3 Mpod Mini crate

The WIENER Mpod mini crate represents a compact 19" rack mountable chassis for up to 4 Mpod low and high voltage modules. The Mpod mini crate includes the primary power supply with 600W power for high voltage modules as well as a cooling system with high performance DC fan. It can be outfitted with HV backplane for use as a high voltage system only or with both HV and LV backplanes.

The first half slot is reserved for the Mpod Controller which manages the primary power supplies and provides Ethernet, USB and CAN-bus interfaces for remote monitoring and control. Please note that it is possible to switch the Mpod crate off and on off remotely when the front panel switch is in ON position.



Mpod Mini crate with Mpod controller and 2 high voltage + 2 low voltage modules

## 2 LV Modules

The MPV Mpod Low Voltage modules are available with either 4 or 8 channels for different voltage ranges with 8V, 16V, 30V, 60V maximum respectively. Special modules with up to 200V are under development.

All MVP modules have the following features:

- 6U height, 220mm deep fully shielded mechanics
- All DC outputs floating with individual return lines, individually sensed
- Low noise and ripple
- Voltage and current settings / monitoring for each channel, 12 bit resolution
- Current monitoring and limiting for each channel, 12 bit resolution
- Programmable channel parameters:
  - voltage
  - current limit
  - power
  - ramping
  - group features
- programming and monitoring via Ethernet (TCP/IP) and USB
- Connectors: 2 x 8 pin high current sub-D, 37 pin sub-D for sense / control

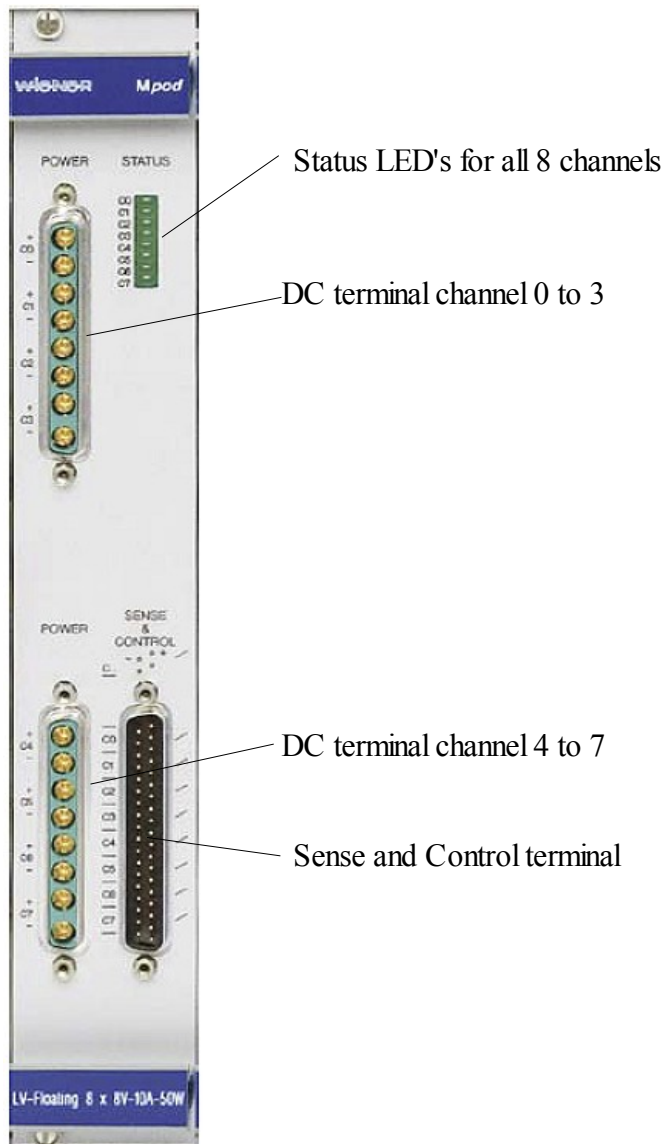

## 2.1 MPOD Low Voltage Module Versions

### MPOD Low Voltage Series, 4 channels with floating ground

LV-Type	Channels	Voltage range	Max Current	Peak power per channel	Resolution V, I	Ripple
MPV 4008	4	0V ... 8V	10A	50W	12bit	<50mV <sub>pp</sub> (<3W) <30mV <sub>pp</sub> (>3W)
MPV 4008L	4	0V ... 8V	5A	40W	12bit	<30mV <sub>pp</sub> (<3W) <10mV <sub>pp</sub> (>3W)
MPV 4015	4	0V ... 16V	5A	50W	12bit	<50mV <sub>pp</sub> (<3W) <30mV <sub>pp</sub> (>3W)
MPV 4015L	4	0V ... 16V	5A	40W	12bit	<30mV <sub>pp</sub> (<3W) <10mV <sub>pp</sub> (>3W)
MPV 4030	4	0V ... 30V	2.5A	50W	12bit	<50mV <sub>pp</sub> (<3W) <30mV <sub>pp</sub> (>3W)
MPV 4030L	4	0V ... 30V	2.5A	50W	12bit	<30mV <sub>pp</sub> (<3W) <10mV <sub>pp</sub> (>3W)
MPV 4060	4	0V ... 60V	1A	50W	12bit	<50mV <sub>pp</sub> (<3W) <30mV <sub>pp</sub> (>3W)
MPV 4060L	4	0V ... 60V	1A	50W	12bit	<30mV <sub>pp</sub> (<3W) <10mV <sub>pp</sub> (>3W)

### MPOD Low Voltage Series, 8 channels with floating ground

LV-Type	Channels	Voltage range	Max Current	Peak power per channel	Resolution V, I	Ripple
MPV 8008	8	0V ... 8V	10A	50W	12bit	<50mV <sub>pp</sub> (<3W) <30mV <sub>pp</sub> (>3W)
MPV 8008L	8	0V ... 8V	5A	40W	12bit	<30mV <sub>pp</sub> (<3W) <10mV <sub>pp</sub> (>3W)
MPV 8015	8	0V ... 16V	5A	50W	12bit	<50mV <sub>pp</sub> (<3W) <30mV <sub>pp</sub> (>3W)
MPV 8015L	8	0V ... 16V	5A	40W	12bit	<30mV <sub>pp</sub> (<3W) <10mV <sub>pp</sub> (>3W)
MPV 8030	8	0V ... 30V	2.5A	50W	12bit	<50mV <sub>pp</sub> (<3W) <30mV <sub>pp</sub> (>3W)
MPV 8030L	8	0V ... 30V	2.5A	50W	12bit	<30mV <sub>pp</sub> (<3W) <10mV <sub>pp</sub> (>3W)
MPV 8060	8	0V ... 60V	1A	50W	12bit	<50mV <sub>pp</sub> (<3W) <30mV <sub>pp</sub> (>3W)
MPV 8060L	8	0V ... 60V	1A	50W	12bit	<30mV <sub>pp</sub> (<3W) <10mV <sub>pp</sub> (>3W)

## 2.2 Sense & Control Connector Pin Assignment

Some pins are reserved for future functionality.

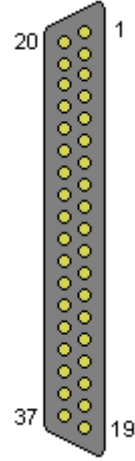
DSUB37 male (Channel 0..7)	Pin	Signal	Comment
	1	S0+	Channel 0 positive Sense Input
	20	S0-	Channel 0 negative Sense Input
	2		reserved
	21		reserved
	3	S1+	Channel 1 positive Sense Input
	22	S1-	Channel 1 negative Sense Input
	4		reserved
	23		reserved
	5	S2+	Channel 2 positive Sense Input
	24	S2-	Channel 2 negative Sense Input
	6		reserved
	25		reserved
	7	S3+	Channel 3 positive Sense Input
	26	S3-	Channel 3 negative Sense Input
	8		reserved
	27		reserved
	9	S4+	Channel 4 positive Sense Input
	28	S4-	Channel 4 negative Sense Input
	10		reserved
29		reserved	
11	S5+	Channel 5 positive Sense Input	
30	S5-	Channel 5 negative Sense Input	
12		reserved	
31		reserved	
13	S6+	Channel 6 positive Sense Input	
32	S6-	Channel 6 negative Sense Input	
14		reserved	
33		reserved	
15	S7+	Channel 7 positive Sense Input	
34	S7-	Channel 7 negative Sense Input	
16		reserved	
35		reserved	
17		reserved	
36		reserved	
18		reserved	
37		reserved	
19		reserved	

### 2.3 Power Connector Pin Assignment

DSUB37-8 female (Channel 0..3)	Pin	Signal	Comment
	1	U0+	Channel 0 positive Output
	2	U0-	Channel 0 negative Output
	3	U1+	Channel 1 positive Output
	4	U1-	Channel 1 negative Output
	5	U2+	Channel 2 positive Output
	6	U2-	Channel 2 negative Output
	7	U3+	Channel 3 positive Output
	8	U3-	Channel 3 negative Output

DSUB37-8 female (Channel 4..7)	Pin	Signal	Comment
	1	U4+	Channel 4 positive Output
	2	U4-	Channel 4 negative Output
	3	U5+	Channel 5 positive Output
	4	U5-	Channel 5 negative Output
	5	U6+	Channel 6 positive Output
	6	U6-	Channel 6 negative Output
	7	U7+	Channel 7 positive Output
	8	U7-	Channel 7 negative Output

**Matching cable plug:**

e.g. Erni TMC – P - 8W8 male, unloaded connector (103448) + pins

<http://www.erni.com/DB/PDF/TMC/ERNI-D-SubHighPower0101-e.pdf>

### 3 HV Modules

MPOD high voltage modules are manufactured by ISEG. For technical details please refer to the ISEG manuals and data sheets of the EHQ, EHS and EDS multi channel high voltage modules. General features are:

- High Voltage modules with 4, 8, 16 or 32 individually controlled channels
- Maximum voltage range from 500V up to 6 kV
- Extremely low noise and ripple: <5mVpp to <10mVpp
- All DC outputs floating or common ground depending on module type
- Voltage and current settings / monitoring for each channel, 16 to 21 bit resolution
- Current monitoring and limiting for each channel, 16 to 21 bit resolution
- Programmable channel parameters, group features
- output connectors:
 

8 channel modules	SHV or REDEL (<4kV) multi pin Kings for 8kV and 10kV (4 channels only)
16 channel modules	SHV or REDEL (<4kV) multi pin
32 channel modules	REDEL multi pin

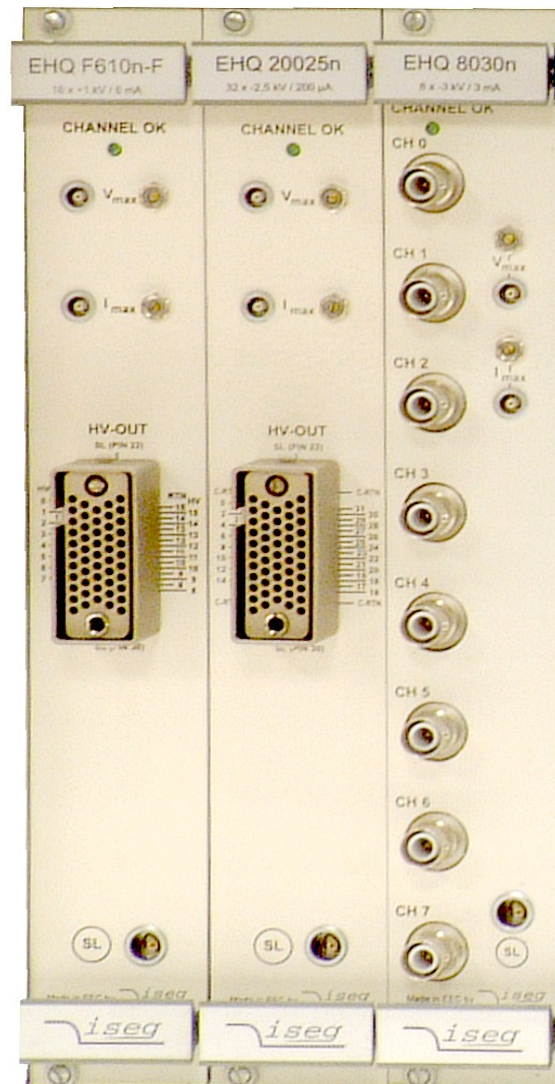

16, 32 and 8 channel ISEG high voltage modules (from left to right) with Redel multipin connectors and SHV



### EHS Series, 8 / 16 channels with common ground

Type	Channels	V max	I max	V res	I res	Ripple
EHS 80010x_504	4	10kV	0.5mA	$10^{-5} - 10^{-6} V_{max}$	$10^{-5} - 10^{-6} I_{max}$	<100 mV
EHS 8080x_105	8	8kV	1mA	$10^{-5} - 10^{-6} V_{max}$	$10^{-5} - 10^{-6} I_{max}$	<50mV
EHS 8060x_105	8	6kV	1mA	$10^{-5} - 10^{-6} V_{max}$	$10^{-5} - 10^{-6} I_{max}$	<50 mV
EHS 8040x_205	8	4kV	2mA	$10^{-5} - 10^{-6} V_{max}$	$10^{-5} - 10^{-6} I_{max}$	<5mV
EHS 8030x_305	8	3kV	3mA	$10^{-5} - 10^{-6} V_{max}$	$10^{-5} - 10^{-6} I_{max}$	<5mV
EHS 8020x_405	8	2kV	4mA	$10^{-5} - 10^{-6} V_{max}$	$10^{-5} - 10^{-6} I_{max}$	<5mV
EHS 8010x_805	8	1kV	8mA	$10^{-5} - 10^{-6} V_{max}$	$10^{-5} - 10^{-6} I_{max}$	<5 mV
EHS 8005x_156	8	500V	15mA	$10^{-5} - 10^{-6} V_{max}$	$10^{-5} - 10^{-6} I_{max}$	<5mV
EHS F060x_105	16	6kV	1mA	$10^{-5} - 10^{-6} V_{max}$	$10^{-5} - 10^{-6} I_{max}$	<50mV
EHS F040x_205	16	4kV	2mA	$10^{-5} - 10^{-6} V_{max}$	$10^{-5} - 10^{-6} I_{max}$	<5mV
EHS F030x_305	16	3kV	3mA	$10^{-5} - 10^{-6} V_{max}$	$10^{-5} - 10^{-6} I_{max}$	<5 mV
EHS F020x_405	16	2kV	4mA	$10^{-5} - 10^{-6} V_{max}$	$10^{-5} - 10^{-6} I_{max}$	<5mV
EHS F010x_805	16	1kV	8mA	$10^{-5} - 10^{-6} V_{max}$	$10^{-5} - 10^{-6} I_{max}$	<5mV
EHS F005x_156	16	500V	15mA	$10^{-5} - 10^{-6} V_{max}$	$10^{-5} - 10^{-6} I_{max}$	<5mV

### EHS Series, 8 / 16 channels with floating ground

Type	Channels	V max	I max	V res	I res	Ripple
EHS 8660x_105-F	8	6kV	1mA	$10^{-5} - 10^{-6} V_{max}$	$10^{-5} - 10^{-6} I_{max}$	<50mV
EHS 8640x_205-F	8	4kV	2mA	$10^{-5} - 10^{-6} V_{max}$	$10^{-5} - 10^{-6} I_{max}$	<10mV
EHS 8630x_305-F	8	3kV	3mA	$10^{-5} - 10^{-6} V_{max}$	$10^{-5} - 10^{-6} I_{max}$	<10mV
EHS 8620x_405-F	8	2kV	4mA	$10^{-5} - 10^{-6} V_{max}$	$10^{-5} - 10^{-6} I_{max}$	<10mV
EHS 8610x_805-F	8	1kV	8mA	$10^{-5} - 10^{-6} V_{max}$	$10^{-5} - 10^{-6} I_{max}$	<10mV
EHS 8605x_156-F	8	500V	15mA	$10^{-5} - 10^{-6} V_{max}$	$10^{-5} - 10^{-6} I_{max}$	<10mV
EHS F660x_105-F	16	6kV	1mA	$10^{-5} - 10^{-6} V_{max}$	$10^{-5} - 10^{-6} I_{max}$	<50mV
EHS F640x_205-F	16	4kV	2mA	$10^{-5} - 10^{-6} V_{max}$	$10^{-5} - 10^{-6} I_{max}$	<10mV
EHS F630x_305-F	16	3kV	3mA	$10^{-5} - 10^{-6} V_{max}$	$10^{-5} - 10^{-6} I_{max}$	<10mV
EHS F620x_405-F	16	2kV	4mA	$10^{-5} - 10^{-6} V_{max}$	$10^{-5} - 10^{-6} I_{max}$	<10mV
EHS F610x_805-F	16	1kV	8mA	$10^{-5} - 10^{-6} V_{max}$	$10^{-5} - 10^{-6} I_{max}$	<10mV
EHS F605x_156-F	16	500V	15mA	$10^{-5} - 10^{-6} V_{max}$	$10^{-5} - 10^{-6} I_{max}$	<10mV

### EHQ Series high precision series, 8 / 16 channels with floating ground

Type	Channels	V max	I max	V res	I res	Ripple
				1mV	5nA	<5mV
EHQ 82 05x_156-F	8	500V	15mA	0.5mV	15nA	<5mV
EHQ F210x_505-F	16	1kV	5mA	1mV	5nA	<5mV
EHQ F205x_106-F	16	500V	10mA	0.5mV	15nA	<5mV

### EDS Distribution Series, 16 / 32 channels with common ground

Type	Channels	V max	I max	V res	I res	Ripple
EDS F0 05x_105	16	500V	1mA	10mV	$10^{-5} - 10^{-6} I_{max}$	<10mV
EDS F0 05x_105	16	2.5V	500uA	60mV	$10^{-5} - 10^{-6} I_{max}$	<10mV
EDS F1 30x_504	16	3kV	500uA	60mV	$10^{-5} - 10^{-6} I_{max}$	<10mV
EDS 20 005x_105	32	500V	1mA	10mV	$10^{-5} - 10^{-6} I_{max}$	<10mV
EDS 20 025x_504	32	2.5kV	500uA	60mV	$10^{-5} - 10^{-6} I_{max}$	<10mV
EDS 21 030x_504	32	3kV	500uA	60mV	$10^{-5} - 10^{-6} I_{max}$	<10mV

### EBS Bipolar High voltage modules, 8 / 16 channels with common ground

Type	Channels	V max	I max	V res	I res	Ripple
EBS 80 05	16	+500V	+1mA	20mV	$10^{-5} - 10^{-6} I_{max}$	<10mV
EBS F0 05	16	+500V	+1mA	20mV	$10^{-5} - 10^{-6} I_{max}$	<10mV
EBS 80 30	8	+3kV	+500uA	50mV	$10^{-5} - 10^{-6} I_{max}$	<10mV
EDS F0 30	16	+3kV	+500uA	50mV	$10^{-5} - 10^{-6} I_{max}$	<10mV

## 4 Mpod Controller

The Mpod controller which is plugged into the first half slot of the crate controls the primary power supply as well as all inserted LV- and HV-modules. Further it connects these to remote controlling interfaces / services in a unique way.

Mpod Controller features:

- TCP/IP 10M/100M port, auto ranging
- Built-in HTTP server
- TCP/IP protocol with SNMP v.2c for full control of all module parameters
- 2 CAN-Bus ports, wired in parallel for daisy-chaining
- USB 2 interface
- 3 status LED's
- Interlock connector

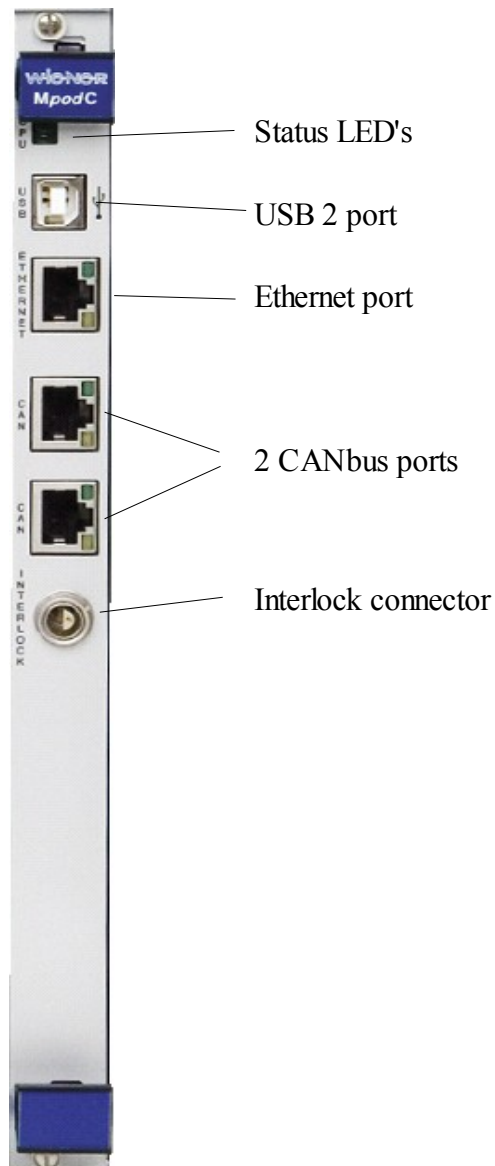

### Ethernet port, standard NIC pin layout

RJ45	Pin	Signal	Comment
 8 1	1	TX+	
	2	TX-	
	3	RX+	
	4	GND 1	75 Ohm
	5	GND 1	
	6	RX-	
	7	GND 2	75 Ohm
	8	GND 2	

### CAN-bus ports

RJ45	Pin	Signal	Comment
 8 1	1	CAN-H	
	2	CAN-L	
	3	GND	
	4	n.c.	
	5	n.c.	
	6	reserved	
	7	GND	
	8	n.c.	

## 5 Remote Control / Software

### 5.1 Software Setup for Microsoft Windows

Before the Mpod Controller can be used, it has to be configured according to the network environment.

This is done by the MUSEcontrol utility, which allows access to the USB-port of the Mpod Controller with a computer running 32-bit Windows XP or VISTA. The software is free available on the download area at [www.wiener-d.com](http://www.wiener-d.com).

Run the MUSEControl.msi Program to install all drivers and the USB program itself. It is recommended to define a short path for the driver location during installation. Connecting the MPOD Controller via USB it should be automatically detected and the Silicon Labs USB drivers (SiLib.sys and SiUSBXp.sys) loaded



Starting the program, the main window gives a quick overview of the Mpod and its connected LV-Modules.

File	Switch...	SelectOutput	DVM	OutputConfiguration	OutputCalibration	System	Stop	Help
U4	Usense:	3.000V	I: -0.005A	Umodule:	3.165V	Status: ON		
U5	Usense:	3.999V	I: -0.004A	Umodule:	4.219V	Status: ON		
U6	Usense:	5.001V	I: 0.009A	Umodule:	5.274V	Status: ON		
U7	Usense:	5.999V	I: -0.006A	Umodule:	6.330V	Status: ON		

In case no low voltage modules are located in the crate an error message “No module found” will pop up which should be ignored.

To prepare the MPOD controller select System → Configuration which starts the network configuration dialog as shown below.

Here you enter the TCP/IP network settings (IP address, subnet mask and default gateway).

You have to use the parameters of your local network here. Please contact your network administrator for details.

HTTP and SNMP port numbers should only be modified if you know what you do. Setting any ports to 0 disables the server.

The “First LV Slot” item is an intermediate solution to define the slot number of the first LV-module. Any HV-module plugged into this slot will not be detected. (This setting is necessary because the LV modules do not use geographic addressing to detect their slot number automatically in the moment)

Another essential menu item is the System → FirmwareUpdate which starts the firmware update procedures.

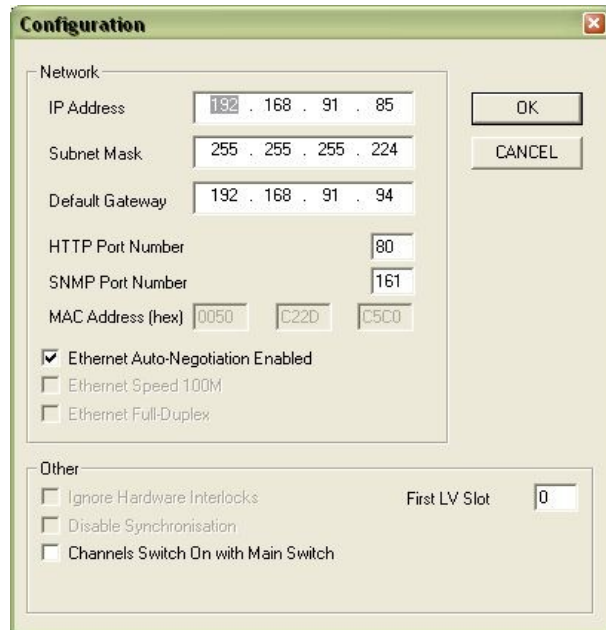

Low Voltage channels can be completely programmed and monitor within the MUSE application. You can switch on or off any channel by clicking at the line of the channel. If you click with the right mouse button, the “OutputConfiguration” dialog is entered:

The dialog is divided into five main sections:

- Measurement**  
 Shows the actual measured sense voltage, terminal voltage (at the module terminals), current, the calculated power and the most critical module temperature.
- Control & Status**  
 Here the channel can be switched on and off. If the channel has switched off because of any failure, the reason is displayed here, too.
- Nominal Values**  
 Here the nominal output voltage (sense voltage), current limit and ramping speeds are entered. The “No Ramp at Switch Off” check box forces immediate switch off. The regulation mode can be optimized for different cable lengths (slow regulation requests both check boxes to be checked!)
- Supervision**  
 Here the threshold values of the minimum sense voltage, the maximum sense voltage, the maximum terminal voltage, the maximum current,

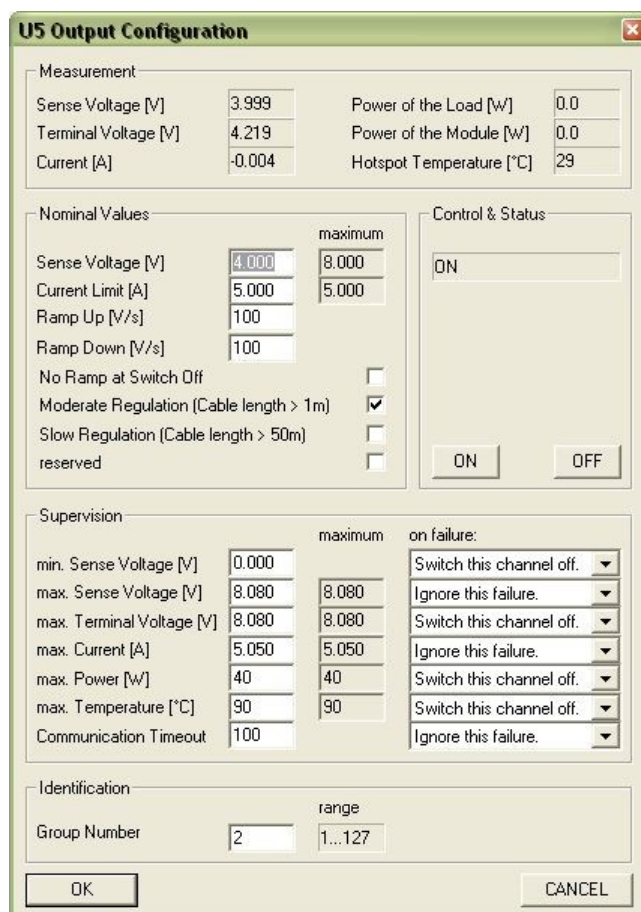

the maximum power, the maximum temperature and the communication timeout can be entered. The right column “maximum” can only be changed by this utility and is the maximum allowed value of the left column. The left column may be changed here or via the TCP/IP network.

The most right column “on failure” defines the action if the associated threshold is exceeded.

The “communication timeout” at the last low is an internal timeout of the communication between different processors. If the processor responsible for a specific output has no data from it's master processor for longer than this time (in milliseconds), the output channel will be switched off.

- **Identification**

Here the group number of this channel can be entered.

Other main menu items associated with this dialog are “Start/Stop” (stop and restart the communication with the Mpod controller via USB) and “SelectOutput”, which simple increments the channel number which is displayed by the other dialogs.

The other main menu items are used for test and maintenance and should not used by the customer.

## 5.2 Web Browser

With a web browser pointing to the IP address as URL it is possible to get an overview of all channels in a simple way.

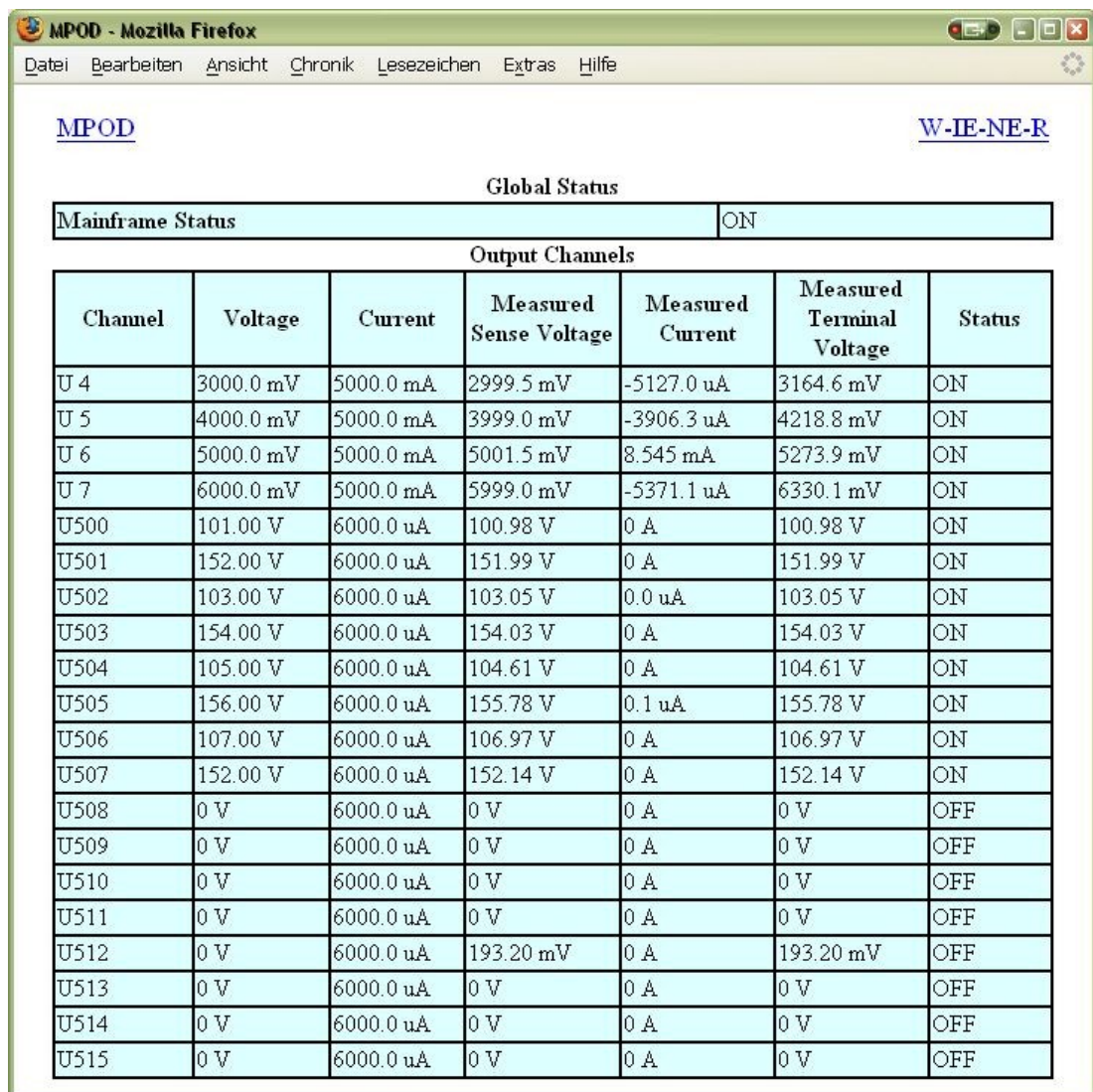

Global Status						
Mainframe Status						ON
Output Channels						
Channel	Voltage	Current	Measured Sense Voltage	Measured Current	Measured Terminal Voltage	Status
U 4	3000.0 mV	5000.0 mA	2999.5 mV	-5127.0 uA	3164.6 mV	ON
U 5	4000.0 mV	5000.0 mA	3999.0 mV	-3906.3 uA	4218.8 mV	ON
U 6	5000.0 mV	5000.0 mA	5001.5 mV	8.545 mA	5273.9 mV	ON
U 7	6000.0 mV	5000.0 mA	5999.0 mV	-5371.1 uA	6330.1 mV	ON
U500	101.00 V	6000.0 uA	100.98 V	0 A	100.98 V	ON
U501	152.00 V	6000.0 uA	151.99 V	0 A	151.99 V	ON
U502	103.00 V	6000.0 uA	103.05 V	0.0 uA	103.05 V	ON
U503	154.00 V	6000.0 uA	154.03 V	0 A	154.03 V	ON
U504	105.00 V	6000.0 uA	104.61 V	0 A	104.61 V	ON
U505	156.00 V	6000.0 uA	155.78 V	0.1 uA	155.78 V	ON
U506	107.00 V	6000.0 uA	106.97 V	0 A	106.97 V	ON
U507	152.00 V	6000.0 uA	152.14 V	0 A	152.14 V	ON
U508	0 V	6000.0 uA	0 V	0 A	0 V	OFF
U509	0 V	6000.0 uA	0 V	0 A	0 V	OFF
U510	0 V	6000.0 uA	0 V	0 A	0 V	OFF
U511	0 V	6000.0 uA	0 V	0 A	0 V	OFF
U512	0 V	6000.0 uA	193.20 mV	0 A	193.20 mV	OFF
U513	0 V	6000.0 uA	0 V	0 A	0 V	OFF
U514	0 V	6000.0 uA	0 V	0 A	0 V	OFF
U515	0 V	6000.0 uA	0 V	0 A	0 V	OFF

### 5.3 NetSNMP

NetSNMP is an open source SNMP program which can be used to access the Mpod controller via the Simple Network Management Protocol. Please see <http://net-snmp.sourceforge.net/> for more details.

Please install netSNMP from the CD-ROM or downloaded from WIENER support web site on the control computer. In order to perform SNMP calls from any WIENER product the WIENER-CRATE-MIB file must be stored somewhere on the PC doing the calls, by default that location should be /usr/share/snmp/mibs (Windows: C:\usr\share\snmp\mibs).

The most commonly used net-snmp calls are:

**snmpwalk** – returns groups of parameters / items

**snmpget** – returns a specific parameter (read)

**snmpset** – sets a specific parameter (write)

Please see the Net-snmp description and help files for detailed instructions and options. All parameters defined for the WIENER Mpod system as well as crates and other power supplies are contained within the WIENER-CRATE-MIB.txt file.

A fast and easy way to begin using SNMP is to use command line arguments. The command line arguments specified in this document are based on netSNMP. The command line syntax is the same for both windows and Linux (and probably MAC OSX).

A first communication with the Mpod crate can be done using the snmpwalk to confirm the existence of the power supply at the given IP address.

**snmpwalk -Cp -Oqv -v 2c -M \$path -m +WIENER-CRATE-MIB -c public \$ip**

with:

**snmpwalk:** This command will retrieve a block of information.

**-v 2c:** This parameter specifies which version of the SNMP to use. WIENER devices use SNMP 2C.

**-M \$path:** This parameter should be replaced with the path to the WIENER-CRATE-MIB.txt file. It is not needed in case the default path is used.

**-m +WIENER-CRATE-MIB:** This parameter tells the command to look at the WIENER-CRATE-MIB to resolve the OID name.

**-c public:** This specifies which community of values can be accessed.

**\$ip:** This should be replaced with the IP address of the MPOD crate.

Example for crate with IP address 192.168.2.25:

**snmpwalk -v 2c -m +WIENER-CRATE-MIB -c public 192.168.2.25**

returns:

*SNMPv2-MIB::sysDescr.0 = STRING: WIENER MPOD (4193086, MPOD 1.1.1.6, MPODslave 1.06)*

*SNMPv2-MIB::sysObjectID.0 = OID: WIENER-CRATE-MIB::sysMainSwitch.0*

*SNMPv2-MIB::sysUpTime.0 = Timeticks: (13401) 0:02:14.01*

*SNMPv2-MIB::sysContact.0 = STRING:*

*SNMPv2-MIB::sysName.0 = STRING:*

*SNMPv2-MIB::sysLocation.0 = STRING:*

*SNMPv2-MIB::sysServices.0 = INTEGER: 79*

A list of all available parameters or sub-parameters as for instance channels can be obtained using the command snmpwalk with the paramtere “crate”. To get all parameters use:

**snmpwalk -Cp -Oqv -v 2c -M \$path -m +WIENER-CRATE-MIB -c public \$ip crate**

example:

**snmpwalk -v 2c -m +WIENER-CRATE-MIB -c public 192.168.2.25 crate**

Further it is possible obtain the array of names or values for a specific parameter. The following command provides a list of all existing output channels:

**snmpwalk -Cp -Oqv -v 2c -M \$path -m +WIENER-CRATE-MIB -c public \$ip outputName**

Example:

**snmpwalk -v 2c -m +WIENER-CRATE-MIB -c public 192.168.2.25 outputName**

returns for MPOD system with 2 ISEG EHS HV modules (8 channels each) in slot 2 and 3:

```

WIENER-CRATE-MIB::outputName.101 = STRING: U100
WIENER-CRATE-MIB::outputName.102 = STRING: U101
WIENER-CRATE-MIB::outputName.103 = STRING: U102
WIENER-CRATE-MIB::outputName.104 = STRING: U103
WIENER-CRATE-MIB::outputName.105 = STRING: U104
WIENER-CRATE-MIB::outputName.106 = STRING: U105
WIENER-CRATE-MIB::outputName.107 = STRING: U106
WIENER-CRATE-MIB::outputName.108 = STRING: U107
WIENER-CRATE-MIB::outputName.201 = STRING: U200
WIENER-CRATE-MIB::outputName.202 = STRING: U201
WIENER-CRATE-MIB::outputName.203 = STRING: U202
WIENER-CRATE-MIB::outputName.204 = STRING: U203
WIENER-CRATE-MIB::outputName.205 = STRING: U204
WIENER-CRATE-MIB::outputName.206 = STRING: U205
WIENER-CRATE-MIB::outputName.207 = STRING: U206
WIENER-CRATE-MIB::outputName.208 = STRING: U207

```

This example returns 16 index numbers. Please note the following geographic module and channel number coding for the SNMP call indexes, where the first digit is defined by the slot number and the following two by the channel of the particular module in this slot:

Slot	Channel	Name	index
<b>1</b>	<b>0 to 98</b>	<b>Uxx</b>	<b>.001 to .099</b>
<b>2</b>	<b>0 to 98</b>	<b>U1xx</b>	<b>.101 to .199</b>
...	...	...	...
<b>10</b>	<b>0 to 98</b>	<b>U9xx</b>	<b>.901 to .999</b>

In case of multi crate system there will be an additional digit for the crate number:

Name = 1000 \* crate + 100\*slot + channel  
index = 1000 \* crate + 100\*slot + channel

(crate: 0 .... 9, slot: 0 ... 9 , channel: 0 ... 99)



To see all Output channel set voltage values use snmpwalk with outputVoltage:

```
snmpwalk -Cp -Oqv -v 2c -M $path -m +WIENER-CRATE-MIB -c public $ip outputVoltage
```

Example:

```
snmpwalk -v 2c -m +WIENER-CRATE-MIB -c public 192.168.2.25 outputVoltage
```

returns for a MPOD system with one 8 channel ISEG EHS HV module in slot 3:

```
WIENER-CRATE-MIB::outputVoltage.201 = Opaque: Float: 0.000000 V  
WIENER-CRATE-MIB::outputVoltage.202 = Opaque: Float: 0.000000 V  
WIENER-CRATE-MIB::outputVoltage.203 = Opaque: Float: 0.000000 V  
WIENER-CRATE-MIB::outputVoltage.204 = Opaque: Float: 0.000000 V  
WIENER-CRATE-MIB::outputVoltage.205 = Opaque: Float: 0.000000 V  
WIENER-CRATE-MIB::outputVoltage.206 = Opaque: Float: 0.000000 V  
WIENER-CRATE-MIB::outputVoltage.207 = Opaque: Float: 0.000000 V  
WIENER-CRATE-MIB::outputVoltage.208 = Opaque: Float: 0.000000 V
```

After obtaining information about the power supplies or a list of channels and parameters, it is useful to be able to write or read information about it. This can be done using the **snmpget** and **snmpset** commands.

```
snmpget -Oqv -v 2c -M $path -m +WIENER-CRATE-MIB -c guru $ip name.index
```

```
snmpset -v 2c -M $path -m +WIENER-CRATE-MIB -c guru $ip name.index format value
```

The most common kind of call you will want is to get data from the power supply. This is easily done via the **snmpget** command. The example below retrieves information about whether the main power for the crate is on. If you wish to test this example on your own system replace “\$path” with the path to WIENER-CRATE-MIB.txt (/usr/share/snmp/mibs by default and “\$ip” with the ip address of your MPOD (see following examples).

```
snmpget -v 2c -M $path -m +WIENER-CRATE-MIB -c public $ip sysMainSwitch.0  
WIENER-CRATE-MIB::sysMainSwitch.0 = INTEGER: OFF(0)
```

This indicates that the MPOD crate is currently off. To better understand the call above we will break it down by parameter:

**snmpget:** This command will retrieve a value about the MPOD crate or one of the channels it houses..

**-v 2c:** This parameters specifies which version of the SNMP to use. WIENER devices use SNMP 2C.

**-M \$path:** This parameter should be replaced with the path to the WIENER-CRATE-MIB.txt file.

**-m +WIENER-CRATE-MIB:** This parameter tells the command to look at the WIENER-CRATE-MIB to resolve the OID name.

**-c public:** This specifies which community of values can be accessed.

**\$ip:** This should be replaced with the IP address of the MPOD crate.

**sysMainSwitch.0:**

This is the register you wish to retrieve.

Since we know from the call above that the crate is off, we may want to turn it on. (Software power cycling is only possible if the green mains switch on the MPOD is “ON”, this is to prevent a remote user to override a local user and adds a level of safety to the unit.) To turn MPOD on, we can use the command:

```
snmpset -v 2c - path -m +WIENER-CRATE-MIB -c public $ip sysMainSwitch.0 i 1
```

Most of the parameters for snmpset are the same as snmpget, the new parameters are highlighted below.

**i:** Since sysMainSwitch.0 is an integer value, we specify the value to be an integer with.

**1:** This is the value we wish to write. In this case we write ‘one’ to set the main switch to on.

For most of the write commands (snmpset) the access type has to be changed from public to guru.

A complete list of value names that can be written or read via SNMP can be found in the WIENER-CRATE-MIB but commonly needed values are:

Value Name	Type	Access	Comments
<b>outputVoltage</b>	Float	R/W	The Channel set Voltage
<b>outputCurrent</b>	Float	R/W	The channel current limit
<b>outputMeasurementSenseVoltage</b>	Float	R	Actual channel Voltage
<b>outputMeasurementCurrent</b>	Float	R	Actual channel current
<b>outputSwitch</b>	Integer	R/W	Turns channel ON/OFF
<b>outputVoltageRiseRate</b>	Float	R/W	Channel ramp rate
<b>outputStatus</b>	Bits	R	Channel Status information

For example, to read channel set voltage use:

```
snmpget -Oqv -v 2c -M $path -m +WIENER-CRATE-MIB -c guru $ip outputVoltage.index
```

Example:

```
snmpget -v 2c -m +WIENER-CRATE-MIB -c public 192.168.2.25 outputVoltage.001  
WIENER-CRATE-MIB::outputVoltage.u0 = Opaque: Float: 0.000000 V
```

Write and read individual set voltages, “guru” access needed to write!

```
snmpset -v 2c -m +WIENER-CRATE-MIB -c guru 192.168.2.25 outputVoltage.101 F 200  
WIENER-CRATE-MIB::outputVoltage.101 = Opaque: Float: 200.000000 V
```

Note the “F” before the 200, this indicates that the value is a floating point number. This value can be read back via:

```
snmpget -v 2c -m +WIENER-CRATE-MIB -c public 192.168.2.25 outputVoltage.101  
WIENER-CRATE-MIB::outputVoltage.101 = Opaque: Float: 200.000000 V
```

Turning Channels ON/OFF - The individual channels of an MPOD system low or high voltage module can be turned on or off using the snmpset command. To turn on channel Ux:

```
snmpset -Oqv -v 2c -M $path -m +WIENER-CRATE-MIB -c guru $ip
outputSwitch.index i 1
```

The same channel can be turned off with:

```
snmpset -Oqv -v 2c -M $path -m +WIENER-CRATE-MIB -c guru $ip
outputSwitch.index i 0
```

Example:

```
snmpset -v 2c -m +WIENER-CRATE-MIB -c guru 192.168.2.25 outputSwitch.001 i 1
```

MPOD low and high voltage modules have programmable voltage ramp speeds. The WIENER low voltage modules allow different ramp up and down values for each channel whereas for ISEG modules with common ramp the channel-ID can be any channel of the module! For write access “guru” is needed:

```
snmpset -Oqv -v 2c -M $path -m +WIENER-CRATE-MIB -c guru $ip
outputVoltageRiseRate.index F value
```

Example:

```
snmpset -v 2c -m +WIENER-CRATE-MIB -c guru 192.168.2.25
outputVoltageRiseRate.101 F 10
```

```
WIENER-CRATE-MIB::outputVoltageRiseRate.101 = Opaque: Float: 10.000000 V/s
```

```
snmpget -v 2c -m +WIENER-CRATE-MIB -c public 192.168.2.25
outputVoltageRiseRate.101
```

```
WIENER-CRATE-MIB::outputVoltageRiseRate.101 = Opaque: Float: 10.000000 V/s
```

## 5.4 A BASH Simple Script for SNMP

All of the commands above could be combined into scripts to set and monitor a predefined set of channels. For example a Bash script to read all channels and set the voltages and current limit to the same value for each channel could look like:

```
#!/bin/bash
# Simple Bash Script that will read and set all channels in a MPOD crate

ip=192.168.2.25
path=/usr/share/snmp/mibs
setVoltage=5
setCurrent=.100
setStatus=1
setRamp=100

channelCount=$(snmpget -Oqv -v 2c -M $path -m +WIENER-CRATE-MIB -c guru $ip
outputNumber.0)
indices=$(snmpwalk -Oqv -v 2c -M $path -m +WIENER-CRATE-MIB -c guru $ip
outputIndex)
x=('echo $indices | tr ' ' ')

COUNTER=0
while [ $COUNTER -lt $channelCount ]; do
  index=$(echo ${x[$COUNTER]})

  voltage=$(snmpset -OqvU -v 2c -M $path -m +WIENER-CRATE-MIB -c guru $ip
outputVoltage.$index F $setVoltage)
```

```

iLimit=$(snmpset -OqvU -v 2c -M $path -m +WIENER-CRATE-MIB -c guru $ip
outputCurrent.$index F $setCurrent)
rampspeed=$(snmpset -OqvU -v 2c -M $path -m +WIENER-CRATE-MIB -c guru $ip
outputVoltageRiseRate.$index F $setRamp)
status=$(snmpset -OqvU -v 2c -M $path -m +WIENER-CRATE-MIB -c guru $ip
outputSwitch.$index i $setStatus)

voltage=$(snmpget -OqvU -v 2c -M $path -m +WIENER-CRATE-MIB -c guru $ip
outputVoltage.$index)
iLimit=$(snmpget -OqvU -v 2c -M $path -m +WIENER-CRATE-MIB -c guru $ip
outputCurrent.$index)
sense=$(snmpget -OqvU -v 2c -M $path -m +WIENER-CRATE-MIB -c guru $ip
outputMeasurementSenseVoltage.$index)
current=$(snmpget -OqvU -v 2c -M $path -m +WIENER-CRATE-MIB -c guru $ip
outputMeasurementCurrent.$index)
rampspeed=$(snmpget -OqvU -v 2c -M $path -m +WIENER-CRATE-MIB -c guru $ip
outputVoltageRiseRate.$index)
status=$(snmpget -OqvU -v 2c -M $path -m +WIENER-CRATE-MIB -c guru $ip
outputSwitch.$index)

echo "$voltage $iLimit $sense $current $rampspeed $status"

let COUNTER=COUNTER+1
done

```

## 5.5 Mpod SNMP Parameter List

Parameter	Multi	Access	Type
sysMainSwitch	1	R/W	i
sysStatus	1	R/W	i
sysVmeSysReset	1	R/W	i
outputNumber	1	R	i
groupsNumber	1	R	i
outputName	320	R	str
outputGroup	320	R	i
outputStatus	320	R	i
outputMeasurementSenseVoltage	320	R	F
outputMeasurementTerminalVoltage	320	R	F
outputMeasurementCurrent	320	R	F
outputMeasurementTemperature	320	R	i
outputSwitch	320	R/W	i
outputVoltage	320	R/W	F
outputCurrent	320	R/W	F
outputVoltageRiseRate	320	R/W	F
outputVoltageFallRate	320	R/W	F
outputSupervisionBehavior	320	R/W	i
outputSupervisionMinSenseVoltage	320	R/W	F
outputSupervisionMaxSenseVoltage	320	R/W	F
outputSupervisionMaxTerminalVoltage	320	R/W	F
outputSupervisionMaxCurrent	320	R/W	F
outputSupervisionMaxTemperature	320	R/W	i
outputConfigMaxSenseVoltage	320	R	F
outputConfigMaxTerminalVoltage	320	R	F
outputConfigMaxCurrent	320	R	F
outputConfigMaxPower	320	R	F
sensorNumber	1	R	i
sensorTemperature	12	R	i
sensorWarningThreshold	12	R/W	i
sensorFailureThreshold	12	R/W	i
snmpCommunityName	4	R/W	str
psFirmwareVersion	1	R	str
psSerialNumber	1	R	str
psOperatingTime	1	R	i
psDirectAccess	1	R/W	string
fanFirmwareVersion	1	R	string
fanSerialNumber	1	R	string
fanOperatingTime	1	R	i
fanAirTemperature	1	R	i
fanSwicthOffDelay	1	R/W	i
fanNominalSpeed	1	R/W	i
fanNumberOfFans	1	R	i
fanSpeed	6	R	i

(see SNMP tree structure at end of manual)

## 5.6 LabView Control Program (NETSNMP)

All LabView MPOD function VI's are using SNMP calls from the WIENER\_SNMP\_Basic.dll. This DLL requires NETSNMP and the WIENER -CRATE-MIB.txt file as described above!

The LabView Control program VI's SNMP\_MPOD\_xxx.vi allow controlling both low and high voltage channels for small configurations of a few Mpod modules. The program can run in parallel to web monitoring. Please run SNMP\_MPOD\_xxx.vi with either LabView 8.0 / 8.2 or 8.5.

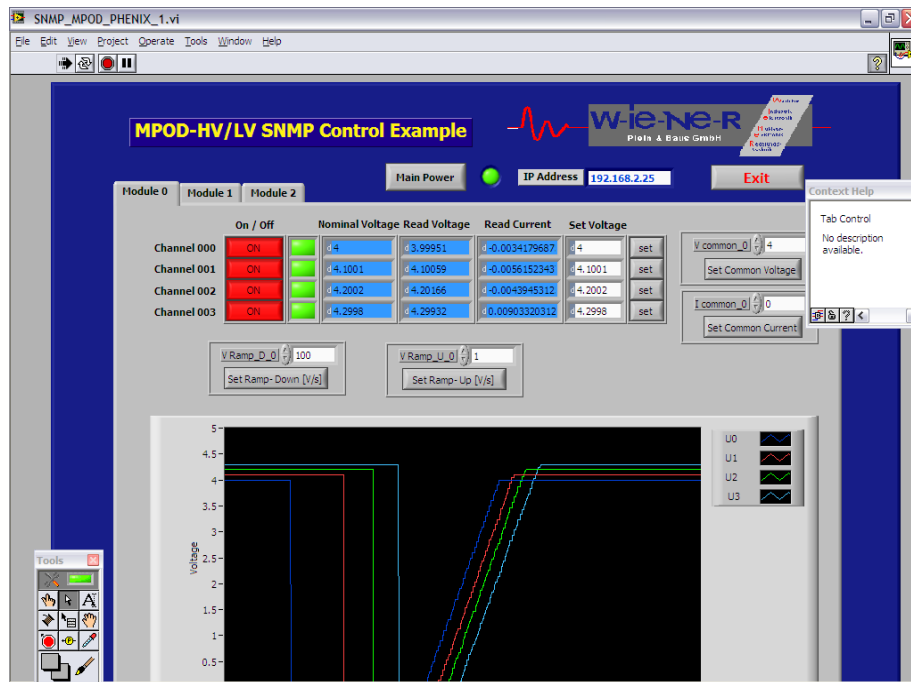

Example for LabView VI for 4 channel low voltage module

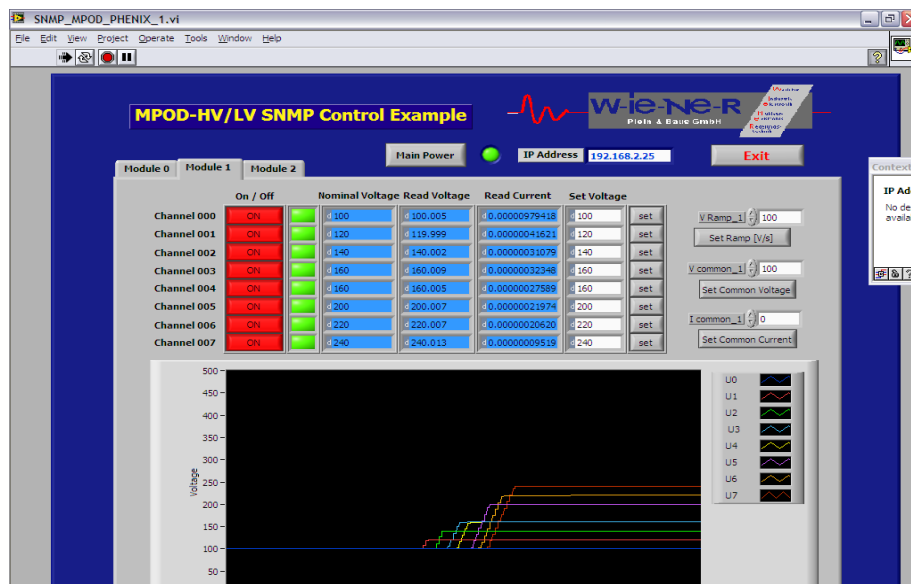

Example for LabView VI for 8 channel high voltage module

## 5.7 C++ programming (NetSNMP)

Using NetSNMP C++ programs can be easily written for monitoring and control of Mpod low / high voltage modules. For Windows all needed functions are provided by a dynamically loadable library.

## 6 Mpod Crate

Powered chassis for multi-channel low and high voltage modules

<b>Construction Features, Accessories:</b>	<b>8 or 9U x 19" crate</b>	max.10 modules, up to3 kW output power / 3,6kW input power
	<b>Slots:</b>	10 + ½ (MPOD controller)
	<b>Dimensions (w, h, d)</b>	434 mm x 132 mm x 325 mm
	<b>Weight:</b>	31,5 kg

## 7 Primary Power Supply

The power supply provides all necessary supply voltages for the LV- and HV-Modules. It is connected to the mains (World wide input 100..240V AC, 50..60 Hz).

- World wide input: 100..240V AC, 50..60 Hz, single phase
- Sinusoidal current input, up to 16A, depending on the used modules

### 7.1 Power Box Data Sheet

3U box with max. 6 power modules.

#### Mains Input

<b>Rated Input Voltage:</b>		106 – 230 V AC, +/- 15% variation allowed
<b>Rated Input Current:</b>		16 A
<b>Sinusoidal:</b>	<b>CE</b>	CE EN 60555, IEC 555 pow. fact. 0,98 (230VAC)
<b>Inrush current:</b>		16 A, cold unit
Input protection:		An external fuse or circuit breaker has to be installed (16A max.)
RF rejection:		EN 55 022 Class B, Input and Output
Output protection overload:		current limiting for booster circuits, 90°C cut off temperature
<b>Dimensions:</b>		4U x 14 PU width acc. to IEC 60297, 450 mm deep
<b>Weight:</b>		4,7 kg
<b>Operation temperature:</b>		0...45°C without derating, storage: -30°C ... + 85°C
<b>M T B F</b>	electronics:	40°C ambient: ca. 100 000 h
	integrated fan:	40°C ambient: ca. 65 000 h, 25° ambient >85000h

## 8 Mpod Low Voltage module data sheet

### Regulation fast remote sense circuit (short sensed distance, sense connected to output at the MPOD module):

Static:	MVP 2-8 V	< 15 mV	(+/-100% load, +/- full mains range)
	MVP other voltages	< 0.05 %	(+/-100% load, +/- full DC input range)
Dynamic (0.5 m wire):	MVP 2-8 V	< 100 mV	(50 % - 75 % load change)
	other	< 0.7 %	(50 % - 75 % load change)
Recovery Time:	MVP 2-8V	1%: 0.2 ms 0.1%: 0.5 ms	(50 % - 75 % load change)
	MVP 5-16V, 7-24V	1%: 0.0 ms 0.1%: 1.0 ms	(50 % - 75 % load change)
	MVP 30-60V	1%: 0.5 ms 0.1%: 1.0 ms	(50 % - 75 % load change)
Conditions	Current slope <1000A/ms, 200uF per 1A parallel to load, fast regulation mode selected.		

### Regulation slow remote sense circuit (long sensed distance):

Static:	MVP 2-8V/ 30-60V	< 15 mV	(+/-100% load, +/- full mains range)
	Other	< 0.05 %	(+/-100% load, +/- full mains range)
Dynamic:	Dynamic deviation depends on current slope resp. filter capacitors at load side only 30m cable to load, 0,3mF capacitance at load side, 1V drop at nominal load, 10% - 90 % load change with 3ms slope (50A output= 13,33A/ms) leads to less than 10% temporary output voltage deviation		
Recovery Time (40m wire, 5V at load side, $U_{drop} < 2 V$ ):	MVP 2-7V, 2-8V	10%: <15 ms 1%: <25 ms	(50 % - 75 % load change)
	Other	10%: <15 ms 1%: < 33 ms	(50 % - 75 % load change)



## 9 WIENER SNMP Parameter structure

```
+--crate(1)
+--system(1)
| +-- -RW- EnumVal sysMainSwitch(1)
| | Values: off(0), on(1)
| +-- -R-- BitString sysStatus(2)
| | Values: mainOn(0), mainInhibit(1), localControlOnly(2), inputFailure(3), outputFailure(4),
| | fantrayFailure(5), sensorFailure(6), vmeSysfail(7), plugAndPlayIncompatible(8)
| +-- -RW- EnumVal sysVmeSysReset(3)
| | Values: trigger(1)
| +-- -RW- Integer32 sysDebugMemory8(1024)
| | Range: 0..255
| +-- -RW- Integer32 sysDebugMemory16(1025)
| | Range: 0..65535
| +-- -RW- Integer32 sysDebugMemory32(1026)
| | Range: -2147483648..2147483647
|
+--input(2)
+--output(3)
| +-- -R-- Integer32 outputNumber(1)
| | Range: 0..1999
|
+--outputTable(2)
| |
| | +--outputEntry(1)
| | | Index: outputIndex
| | |
| | +-- ---- EnumVal outputIndex(1)
| | | Values: u0(1), u1(2), u2(3), u3(4), u4(5), u5(6), u6(7), u7(8), u8(9), u9(10), u10(11), u11(12),
| | | u12(13), u13(14), u14(15), u15(16), u16(17), u17(18), u18(19), u19(20), u20(21), u21(22),
| | | u22(23), u23(24), u24(25), u25(26), u26(27), u27(28), u28(29), u29(30), u30(31), u31(32),
| | | u32(33), u33(34), u34(35), u35(36), u36(37), u37(38), u38(39), u39(40), u40(41), u41(42),
| | | u42(43), u43(44), u44(45), u45(46), u46(47), u47(48), u48(49), u49(50), u50(51), u51(52),
| | | u52(53), u53(54), u54(55), u55(56), u56(57), u57(58), u58(59), u59(60), u60(61), u61(62),
| | | u62(63), u63(64), u64(65), u65(66), u66(67), u67(68), u68(69), u69(70), u70(71), u71(72),
| | | u72(73), u73(74), u74(75), u75(76), u76(77), u77(78), u78(79), u79(80), u80(81), u81(82),
| | | u82(83), u83(84), u84(85), u85(86), u86(87), u87(88), u88(89), u89(90), u90(91), u91(92),
| | | u92(93), u93(94), u94(95), u95(96), u96(97), u97(98), u98(99), u99(100), u100(101),
| | | u101(102), u102(103), u103(104), u104(105), u105(106), u106(107), u107(108), u108(109),
| | | u109(110), u110(111), u111(112), u112(113), u113(114), u114(115), u115(116), u116(117),
| | | u117(118), u118(119), u119(120), u120(121), u121(122), u122(123), u123(124), u124(125),
| | | u125(126), u126(127), u127(128), u128(129), u129(130), u130(131), u131(132), u132(133),
| | | u133(134), u134(135), u135(136), u136(137), u137(138), u138(139), u139(140), u140(141),
| | | u141(142), u142(143), u143(144), u144(145), u145(146), u146(147), u147(148), u148(149),
| | | u149(150), u150(151), u151(152), u152(153), u153(154), u154(155), u155(156), u156(157),
| | | u157(158), u158(159), u159(160), u160(161), u161(162), u162(163), u163(164), u164(165),
| | | u165(166), u166(167), u167(168), u168(169), u169(170), u170(171), u171(172), u172(173),
| | | u173(174), u174(175), u175(176), u176(177), u177(178), u178(179), u179(180), u180(181),
| | | u181(182), u182(183), u183(184), u184(185), u185(186), u186(187), u187(188), u188(189),
| | | u189(190), u190(191), u191(192), u192(193), u193(194), u194(195), u195(196), u196(197),
| | | u197(198), u198(199), u199(200), u200(201), u201(202), u202(203), u203(204), u204(205),
| | | u205(206), u206(207), u207(208), u208(209), u209(210), u210(211), u211(212), u212(213),
| | | u213(214), u214(215), u215(216), u216(217), u217(218), u218(219), u219(220), u220(221),
| | | u221(222), u222(223), u223(224), u224(225), u225(226), u226(227), u227(228), u228(229),
| | | u229(230), u230(231), u231(232), u232(233), u233(234), u234(235), u235(236), u236(237),
| | | u237(238), u238(239), u239(240), u240(241), u241(242), u242(243), u243(244), u244(245),
| | | u245(246), u246(247), u247(248), u248(249), u249(250), u250(251), u251(252), u252(253),
| | | u253(254), u254(255), u255(256), u256(257), u257(258), u258(259), u259(260), u260(261),
| | | u261(262), u262(263), u263(264), u264(265), u265(266), u266(267), u267(268), u268(269),
| | | u269(270), u270(271), u271(272), u272(273), u273(274), u274(275), u275(276), u276(277),
| | | u277(278), u278(279), u279(280), u280(281), u281(282), u282(283), u283(284), u284(285),
| | | u285(286), u286(287), u287(288), u288(289), u289(290), u290(291), u291(292), u292(293),
| | | u293(294), u294(295), u295(296), u296(297), u297(298), u298(299), u299(300), u300(301),
```

u301(302), u302(303), u303(304), u304(305), u305(306), u306(307), u307(308), u308(309),  
u309(310), u310(311), u311(312), u312(313), u313(314), u314(315), u315(316), u316(317),  
u317(318), u318(319), u319(320), u320(321), u321(322), u322(323), u323(324), u324(325),  
u325(326), u326(327), u327(328), u328(329), u329(330), u330(331), u331(332), u332(333),  
u333(334), u334(335), u335(336), u336(337), u337(338), u338(339), u339(340), u340(341),  
u341(342), u342(343), u343(344), u344(345), u345(346), u346(347), u347(348), u348(349),  
u349(350), u350(351), u351(352), u352(353), u353(354), u354(355), u355(356), u356(357),  
u357(358), u358(359), u359(360), u360(361), u361(362), u362(363), u363(364), u364(365),  
u365(366), u366(367), u367(368), u368(369), u369(370), u370(371), u371(372), u372(373),  
u373(374), u374(375), u375(376), u376(377), u377(378), u378(379), u379(380), u380(381),  
u381(382), u382(383), u383(384), u384(385), u385(386), u386(387), u387(388), u388(389),  
u389(390), u390(391), u391(392), u392(393), u393(394), u394(395), u395(396), u396(397),  
u397(398), u398(399), u399(400), u400(401), u401(402), u402(403), u403(404), u404(405),  
u405(406), u406(407), u407(408), u408(409), u409(410), u410(411), u411(412), u412(413),  
u413(414), u414(415), u415(416), u416(417), u417(418), u418(419), u419(420), u420(421),  
u421(422), u422(423), u423(424), u424(425), u425(426), u426(427), u427(428), u428(429),  
u429(430), u430(431), u431(432), u432(433), u433(434), u434(435), u435(436), u436(437),  
u437(438), u438(439), u439(440), u440(441), u441(442), u442(443), u443(444), u444(445),  
u445(446), u446(447), u447(448), u448(449), u449(450), u450(451), u451(452), u452(453),  
u453(454), u454(455), u455(456), u456(457), u457(458), u458(459), u459(460), u460(461),  
u461(462), u462(463), u463(464), u464(465), u465(466), u466(467), u467(468), u468(469),  
u469(470), u470(471), u471(472), u472(473), u473(474), u474(475), u475(476), u476(477),  
u477(478), u478(479), u479(480), u480(481), u481(482), u482(483), u483(484), u484(485),  
u485(486), u486(487), u487(488), u488(489), u489(490), u490(491), u491(492), u492(493),  
u493(494), u494(495), u495(496), u496(497), u497(498), u498(499), u499(500), u500(501),  
u501(502), u502(503), u503(504), u504(505), u505(506), u506(507), u507(508), u508(509),  
u509(510), u510(511), u511(512), u512(513), u513(514), u514(515), u515(516), u516(517),  
u517(518), u518(519), u519(520), u520(521), u521(522), u522(523), u523(524), u524(525),  
u525(526), u526(527), u527(528), u528(529), u529(530), u530(531), u531(532), u532(533),  
u533(534), u534(535), u535(536), u536(537), u537(538), u538(539), u539(540), u540(541),  
u541(542), u542(543), u543(544), u544(545), u545(546), u546(547), u547(548), u548(549),  
u549(550), u550(551), u551(552), u552(553), u553(554), u554(555), u555(556), u556(557),  
u557(558), u558(559), u559(560), u560(561), u561(562), u562(563), u563(564), u564(565),  
u565(566), u566(567), u567(568), u568(569), u569(570), u570(571), u571(572), u572(573),  
u573(574), u574(575), u575(576), u576(577), u577(578), u578(579), u579(580), u580(581),  
u581(582), u582(583), u583(584), u584(585), u585(586), u586(587), u587(588), u588(589),  
u589(590), u590(591), u591(592), u592(593), u593(594), u594(595), u595(596), u596(597),  
u597(598), u598(599), u599(600), u600(601), u601(602), u602(603), u603(604), u604(605),  
u605(606), u606(607), u607(608), u608(609), u609(610), u610(611), u611(612), u612(613),  
u613(614), u614(615), u615(616), u616(617), u617(618), u618(619), u619(620), u620(621),  
u621(622), u622(623), u623(624), u624(625), u625(626), u626(627), u627(628), u628(629),  
u629(630), u630(631), u631(632), u632(633), u633(634), u634(635), u635(636), u636(637),  
u637(638), u638(639), u639(640), u640(641), u641(642), u642(643), u643(644), u644(645),  
u645(646), u646(647), u647(648), u648(649), u649(650), u650(651), u651(652), u652(653),  
u653(654), u654(655), u655(656), u656(657), u657(658), u658(659), u659(660), u660(661),  
u661(662), u662(663), u663(664), u664(665), u665(666), u666(667), u667(668), u668(669),  
u669(670), u670(671), u671(672), u672(673), u673(674), u674(675), u675(676), u676(677),  
u677(678), u678(679), u679(680), u680(681), u681(682), u682(683), u683(684), u684(685),  
u685(686), u686(687), u687(688), u688(689), u689(690), u690(691), u691(692), u692(693),  
u693(694), u694(695), u695(696), u696(697), u697(698), u698(699), u699(700), u700(701),  
u701(702), u702(703), u703(704), u704(705), u705(706), u706(707), u707(708), u708(709),  
u709(710), u710(711), u711(712), u712(713), u713(714), u714(715), u715(716), u716(717),  
u717(718), u718(719), u719(720), u720(721), u721(722), u722(723), u723(724), u724(725),  
u725(726), u726(727), u727(728), u728(729), u729(730), u730(731), u731(732), u732(733),  
u733(734), u734(735), u735(736), u736(737), u737(738), u738(739), u739(740), u740(741),  
u741(742), u742(743), u743(744), u744(745), u745(746), u746(747), u747(748), u748(749),  
u749(750), u750(751), u751(752), u752(753), u753(754), u754(755), u755(756), u756(757),  
u757(758), u758(759), u759(760), u760(761), u761(762), u762(763), u763(764), u764(765),  
u765(766), u766(767), u767(768), u768(769), u769(770), u770(771), u771(772), u772(773),  
u773(774), u774(775), u775(776), u776(777), u777(778), u778(779), u779(780), u780(781),  
u781(782), u782(783), u783(784), u784(785), u785(786), u786(787), u787(788), u788(789),  
u789(790), u790(791), u791(792), u792(793), u793(794), u794(795), u795(796), u796(797),  
u797(798), u798(799), u799(800), u800(801), u801(802), u802(803), u803(804), u804(805),  
u805(806), u806(807), u807(808), u808(809), u809(810), u810(811), u811(812), u812(813),

u813(814), u814(815), u815(816), u816(817), u817(818), u818(819), u819(820), u820(821),  
u821(822), u822(823), u823(824), u824(825), u825(826), u826(827), u827(828), u828(829),  
u829(830), u830(831), u831(832), u832(833), u833(834), u834(835), u835(836), u836(837),  
u837(838), u838(839), u839(840), u840(841), u841(842), u842(843), u843(844), u844(845),  
u845(846), u846(847), u847(848), u848(849), u849(850), u850(851), u851(852), u852(853),  
u853(854), u854(855), u855(856), u856(857), u857(858), u858(859), u859(860), u860(861),  
u861(862), u862(863), u863(864), u864(865), u865(866), u866(867), u867(868), u868(869),  
u869(870), u870(871), u871(872), u872(873), u873(874), u874(875), u875(876), u876(877),  
u877(878), u878(879), u879(880), u880(881), u881(882), u882(883), u883(884), u884(885),  
u885(886), u886(887), u887(888), u888(889), u889(890), u890(891), u891(892), u892(893),  
u893(894), u894(895), u895(896), u896(897), u897(898), u898(899), u899(900), u900(901),  
u901(902), u902(903), u903(904), u904(905), u905(906), u906(907), u907(908), u908(909),  
u909(910), u910(911), u911(912), u912(913), u913(914), u914(915), u915(916), u916(917),  
u917(918), u918(919), u919(920), u920(921), u921(922), u922(923), u923(924), u924(925),  
u925(926), u926(927), u927(928), u928(929), u929(930), u930(931), u931(932), u932(933),  
u933(934), u934(935), u935(936), u936(937), u937(938), u938(939), u939(940), u940(941),  
u941(942), u942(943), u943(944), u944(945), u945(946), u946(947), u947(948), u948(949),  
u949(950), u950(951), u951(952), u952(953), u953(954), u954(955), u955(956), u956(957),  
u957(958), u958(959), u959(960), u960(961), u961(962), u962(963), u963(964), u964(965),  
u965(966), u966(967), u967(968), u968(969), u969(970), u970(971), u971(972), u972(973),  
u973(974), u974(975), u975(976), u976(977), u977(978), u978(979), u979(980), u980(981),  
u981(982), u982(983), u983(984), u984(985), u985(986), u986(987), u987(988), u988(989),  
u989(990), u990(991), u991(992), u992(993), u993(994), u994(995), u995(996), u996(997),  
u997(998), u998(999), u999(1000), u1000(1001), u1001(1002), u1002(1003), u1003(1004),  
u1004(1005), u1005(1006), u1006(1007), u1007(1008), u1008(1009), u1009(1010),  
u1010(1011), u1011(1012), u1012(1013), u1013(1014), u1014(1015), u1015(1016),  
u1016(1017), u1017(1018), u1018(1019), u1019(1020), u1020(1021), u1021(1022),  
u1022(1023), u1023(1024), u1024(1025), u1025(1026), u1026(1027), u1027(1028),  
u1028(1029), u1029(1030), u1030(1031), u1031(1032), u1032(1033), u1033(1034),  
u1034(1035), u1035(1036), u1036(1037), u1037(1038), u1038(1039), u1039(1040),  
u1040(1041), u1041(1042), u1042(1043), u1043(1044), u1044(1045), u1045(1046),  
u1046(1047), u1047(1048), u1048(1049), u1049(1050), u1050(1051), u1051(1052),  
u1052(1053), u1053(1054), u1054(1055), u1055(1056), u1056(1057), u1057(1058),  
u1058(1059), u1059(1060), u1060(1061), u1061(1062), u1062(1063), u1063(1064),  
u1064(1065), u1065(1066), u1066(1067), u1067(1068), u1068(1069), u1069(1070),  
u1070(1071), u1071(1072), u1072(1073), u1073(1074), u1074(1075), u1075(1076),  
u1076(1077), u1077(1078), u1078(1079), u1079(1080), u1080(1081), u1081(1082),  
u1082(1083), u1083(1084), u1084(1085), u1085(1086), u1086(1087), u1087(1088),  
u1088(1089), u1089(1090), u1090(1091), u1091(1092), u1092(1093), u1093(1094),  
u1094(1095), u1095(1096), u1096(1097), u1097(1098), u1098(1099), u1099(1100),  
u1100(1101), u1101(1102), u1102(1103), u1103(1104), u1104(1105), u1105(1106),  
u1106(1107), u1107(1108), u1108(1109), u1109(1110), u1110(1111), u1111(1112),  
u1112(1113), u1113(1114), u1114(1115), u1115(1116), u1116(1117), u1117(1118),  
u1118(1119), u1119(1120), u1120(1121), u1121(1122), u1122(1123), u1123(1124),  
u1124(1125), u1125(1126), u1126(1127), u1127(1128), u1128(1129), u1129(1130),  
u1130(1131), u1131(1132), u1132(1133), u1133(1134), u1134(1135), u1135(1136),  
u1136(1137), u1137(1138), u1138(1139), u1139(1140), u1140(1141), u1141(1142),  
u1142(1143), u1143(1144), u1144(1145), u1145(1146), u1146(1147), u1147(1148),  
u1148(1149), u1149(1150), u1150(1151), u1151(1152), u1152(1153), u1153(1154),  
u1154(1155), u1155(1156), u1156(1157), u1157(1158), u1158(1159), u1159(1160),  
u1160(1161), u1161(1162), u1162(1163), u1163(1164), u1164(1165), u1165(1166),  
u1166(1167), u1167(1168), u1168(1169), u1169(1170), u1170(1171), u1171(1172),  
u1172(1173), u1173(1174), u1174(1175), u1175(1176), u1176(1177), u1177(1178),  
u1178(1179), u1179(1180), u1180(1181), u1181(1182), u1182(1183), u1183(1184),  
u1184(1185), u1185(1186), u1186(1187), u1187(1188), u1188(1189), u1189(1190),  
u1190(1191), u1191(1192), u1192(1193), u1193(1194), u1194(1195), u1195(1196),  
u1196(1197), u1197(1198), u1198(1199), u1199(1200), u1200(1201), u1201(1202),  
u1202(1203), u1203(1204), u1204(1205), u1205(1206), u1206(1207), u1207(1208),  
u1208(1209), u1209(1210), u1210(1211), u1211(1212), u1212(1213), u1213(1214),  
u1214(1215), u1215(1216), u1216(1217), u1217(1218), u1218(1219), u1219(1220),  
u1220(1221), u1221(1222), u1222(1223), u1223(1224), u1224(1225), u1225(1226),  
u1226(1227), u1227(1228), u1228(1229), u1229(1230), u1230(1231), u1231(1232),  
u1232(1233), u1233(1234), u1234(1235), u1235(1236), u1236(1237), u1237(1238),  
u1238(1239), u1239(1240), u1240(1241), u1241(1242), u1242(1243), u1243(1244),

u1244(1245), u1245(1246), u1246(1247), u1247(1248), u1248(1249), u1249(1250),  
u1250(1251), u1251(1252), u1252(1253), u1253(1254), u1254(1255), u1255(1256),  
u1256(1257), u1257(1258), u1258(1259), u1259(1260), u1260(1261), u1261(1262),  
u1262(1263), u1263(1264), u1264(1265), u1265(1266), u1266(1267), u1267(1268),  
u1268(1269), u1269(1270), u1270(1271), u1271(1272), u1272(1273), u1273(1274),  
u1274(1275), u1275(1276), u1276(1277), u1277(1278), u1278(1279), u1279(1280),  
u1280(1281), u1281(1282), u1282(1283), u1283(1284), u1284(1285), u1285(1286),  
u1286(1287), u1287(1288), u1288(1289), u1289(1290), u1290(1291), u1291(1292),  
u1292(1293), u1293(1294), u1294(1295), u1295(1296), u1296(1297), u1297(1298),  
u1298(1299), u1299(1300), u1300(1301), u1301(1302), u1302(1303), u1303(1304),  
u1304(1305), u1305(1306), u1306(1307), u1307(1308), u1308(1309), u1309(1310),  
u1310(1311), u1311(1312), u1312(1313), u1313(1314), u1314(1315), u1315(1316),  
u1316(1317), u1317(1318), u1318(1319), u1319(1320), u1320(1321), u1321(1322),  
u1322(1323), u1323(1324), u1324(1325), u1325(1326), u1326(1327), u1327(1328),  
u1328(1329), u1329(1330), u1330(1331), u1331(1332), u1332(1333), u1333(1334),  
u1334(1335), u1335(1336), u1336(1337), u1337(1338), u1338(1339), u1339(1340),  
u1340(1341), u1341(1342), u1342(1343), u1343(1344), u1344(1345), u1345(1346),  
u1346(1347), u1347(1348), u1348(1349), u1349(1350), u1350(1351), u1351(1352),  
u1352(1353), u1353(1354), u1354(1355), u1355(1356), u1356(1357), u1357(1358),  
u1358(1359), u1359(1360), u1360(1361), u1361(1362), u1362(1363), u1363(1364),  
u1364(1365), u1365(1366), u1366(1367), u1367(1368), u1368(1369), u1369(1370),  
u1370(1371), u1371(1372), u1372(1373), u1373(1374), u1374(1375), u1375(1376),  
u1376(1377), u1377(1378), u1378(1379), u1379(1380), u1380(1381), u1381(1382),  
u1382(1383), u1383(1384), u1384(1385), u1385(1386), u1386(1387), u1387(1388),  
u1388(1389), u1389(1390), u1390(1391), u1391(1392), u1392(1393), u1393(1394),  
u1394(1395), u1395(1396), u1396(1397), u1397(1398), u1398(1399), u1399(1400),  
u1400(1401), u1401(1402), u1402(1403), u1403(1404), u1404(1405), u1405(1406),  
u1406(1407), u1407(1408), u1408(1409), u1409(1410), u1410(1411), u1411(1412),  
u1412(1413), u1413(1414), u1414(1415), u1415(1416), u1416(1417), u1417(1418),  
u1418(1419), u1419(1420), u1420(1421), u1421(1422), u1422(1423), u1423(1424),  
u1424(1425), u1425(1426), u1426(1427), u1427(1428), u1428(1429), u1429(1430),  
u1430(1431), u1431(1432), u1432(1433), u1433(1434), u1434(1435), u1435(1436),  
u1436(1437), u1437(1438), u1438(1439), u1439(1440), u1440(1441), u1441(1442),  
u1442(1443), u1443(1444), u1444(1445), u1445(1446), u1446(1447), u1447(1448),  
u1448(1449), u1449(1450), u1450(1451), u1451(1452), u1452(1453), u1453(1454),  
u1454(1455), u1455(1456), u1456(1457), u1457(1458), u1458(1459), u1459(1460),  
u1460(1461), u1461(1462), u1462(1463), u1463(1464), u1464(1465), u1465(1466),  
u1466(1467), u1467(1468), u1468(1469), u1469(1470), u1470(1471), u1471(1472),  
u1472(1473), u1473(1474), u1474(1475), u1475(1476), u1476(1477), u1477(1478),  
u1478(1479), u1479(1480), u1480(1481), u1481(1482), u1482(1483), u1483(1484),  
u1484(1485), u1485(1486), u1486(1487), u1487(1488), u1488(1489), u1489(1490),  
u1490(1491), u1491(1492), u1492(1493), u1493(1494), u1494(1495), u1495(1496),  
u1496(1497), u1497(1498), u1498(1499), u1499(1500), u1500(1501), u1501(1502),  
u1502(1503), u1503(1504), u1504(1505), u1505(1506), u1506(1507), u1507(1508),  
u1508(1509), u1509(1510), u1510(1511), u1511(1512), u1512(1513), u1513(1514),  
u1514(1515), u1515(1516), u1516(1517), u1517(1518), u1518(1519), u1519(1520),  
u1520(1521), u1521(1522), u1522(1523), u1523(1524), u1524(1525), u1525(1526),  
u1526(1527), u1527(1528), u1528(1529), u1529(1530), u1530(1531), u1531(1532),  
u1532(1533), u1533(1534), u1534(1535), u1535(1536), u1536(1537), u1537(1538),  
u1538(1539), u1539(1540), u1540(1541), u1541(1542), u1542(1543), u1543(1544),  
u1544(1545), u1545(1546), u1546(1547), u1547(1548), u1548(1549), u1549(1550),  
u1550(1551), u1551(1552), u1552(1553), u1553(1554), u1554(1555), u1555(1556),  
u1556(1557), u1557(1558), u1558(1559), u1559(1560), u1560(1561), u1561(1562),  
u1562(1563), u1563(1564), u1564(1565), u1565(1566), u1566(1567), u1567(1568),  
u1568(1569), u1569(1570), u1570(1571), u1571(1572), u1572(1573), u1573(1574),  
u1574(1575), u1575(1576), u1576(1577), u1577(1578), u1578(1579), u1579(1580),  
u1580(1581), u1581(1582), u1582(1583), u1583(1584), u1584(1585), u1585(1586),  
u1586(1587), u1587(1588), u1588(1589), u1589(1590), u1590(1591), u1591(1592),  
u1592(1593), u1593(1594), u1594(1595), u1595(1596), u1596(1597), u1597(1598),  
u1598(1599), u1599(1600), u1600(1601), u1601(1602), u1602(1603), u1603(1604),  
u1604(1605), u1605(1606), u1606(1607), u1607(1608), u1608(1609), u1609(1610),  
u1610(1611), u1611(1612), u1612(1613), u1613(1614), u1614(1615), u1615(1616),  
u1616(1617), u1617(1618), u1618(1619), u1619(1620), u1620(1621), u1621(1622),  
u1622(1623), u1623(1624), u1624(1625), u1625(1626), u1626(1627), u1627(1628),

u1628(1629), u1629(1630), u1630(1631), u1631(1632), u1632(1633), u1633(1634),  
u1634(1635), u1635(1636), u1636(1637), u1637(1638), u1638(1639), u1639(1640),  
u1640(1641), u1641(1642), u1642(1643), u1643(1644), u1644(1645), u1645(1646),  
u1646(1647), u1647(1648), u1648(1649), u1649(1650), u1650(1651), u1651(1652),  
u1652(1653), u1653(1654), u1654(1655), u1655(1656), u1656(1657), u1657(1658),  
u1658(1659), u1659(1660), u1660(1661), u1661(1662), u1662(1663), u1663(1664),  
u1664(1665), u1665(1666), u1666(1667), u1667(1668), u1668(1669), u1669(1670),  
u1670(1671), u1671(1672), u1672(1673), u1673(1674), u1674(1675), u1675(1676),  
u1676(1677), u1677(1678), u1678(1679), u1679(1680), u1680(1681), u1681(1682),  
u1682(1683), u1683(1684), u1684(1685), u1685(1686), u1686(1687), u1687(1688),  
u1688(1689), u1689(1690), u1690(1691), u1691(1692), u1692(1693), u1693(1694),  
u1694(1695), u1695(1696), u1696(1697), u1697(1698), u1698(1699), u1699(1700),  
u1700(1701), u1701(1702), u1702(1703), u1703(1704), u1704(1705), u1705(1706),  
u1706(1707), u1707(1708), u1708(1709), u1709(1710), u1710(1711), u1711(1712),  
u1712(1713), u1713(1714), u1714(1715), u1715(1716), u1716(1717), u1717(1718),  
u1718(1719), u1719(1720), u1720(1721), u1721(1722), u1722(1723), u1723(1724),  
u1724(1725), u1725(1726), u1726(1727), u1727(1728), u1728(1729), u1729(1730),  
u1730(1731), u1731(1732), u1732(1733), u1733(1734), u1734(1735), u1735(1736),  
u1736(1737), u1737(1738), u1738(1739), u1739(1740), u1740(1741), u1741(1742),  
u1742(1743), u1743(1744), u1744(1745), u1745(1746), u1746(1747), u1747(1748),  
u1748(1749), u1749(1750), u1750(1751), u1751(1752), u1752(1753), u1753(1754),  
u1754(1755), u1755(1756), u1756(1757), u1757(1758), u1758(1759), u1759(1760),  
u1760(1761), u1761(1762), u1762(1763), u1763(1764), u1764(1765), u1765(1766),  
u1766(1767), u1767(1768), u1768(1769), u1769(1770), u1770(1771), u1771(1772),  
u1772(1773), u1773(1774), u1774(1775), u1775(1776), u1776(1777), u1777(1778),  
u1778(1779), u1779(1780), u1780(1781), u1781(1782), u1782(1783), u1783(1784),  
u1784(1785), u1785(1786), u1786(1787), u1787(1788), u1788(1789), u1789(1790),  
u1790(1791), u1791(1792), u1792(1793), u1793(1794), u1794(1795), u1795(1796),  
u1796(1797), u1797(1798), u1798(1799), u1799(1800), u1800(1801), u1801(1802),  
u1802(1803), u1803(1804), u1804(1805), u1805(1806), u1806(1807), u1807(1808),  
u1808(1809), u1809(1810), u1810(1811), u1811(1812), u1812(1813), u1813(1814),  
u1814(1815), u1815(1816), u1816(1817), u1817(1818), u1818(1819), u1819(1820),  
u1820(1821), u1821(1822), u1822(1823), u1823(1824), u1824(1825), u1825(1826),  
u1826(1827), u1827(1828), u1828(1829), u1829(1830), u1830(1831), u1831(1832),  
u1832(1833), u1833(1834), u1834(1835), u1835(1836), u1836(1837), u1837(1838),  
u1838(1839), u1839(1840), u1840(1841), u1841(1842), u1842(1843), u1843(1844),  
u1844(1845), u1845(1846), u1846(1847), u1847(1848), u1848(1849), u1849(1850),  
u1850(1851), u1851(1852), u1852(1853), u1853(1854), u1854(1855), u1855(1856),  
u1856(1857), u1857(1858), u1858(1859), u1859(1860), u1860(1861), u1861(1862),  
u1862(1863), u1863(1864), u1864(1865), u1865(1866), u1866(1867), u1867(1868),  
u1868(1869), u1869(1870), u1870(1871), u1871(1872), u1872(1873), u1873(1874),  
u1874(1875), u1875(1876), u1876(1877), u1877(1878), u1878(1879), u1879(1880),  
u1880(1881), u1881(1882), u1882(1883), u1883(1884), u1884(1885), u1885(1886),  
u1886(1887), u1887(1888), u1888(1889), u1889(1890), u1890(1891), u1891(1892),  
u1892(1893), u1893(1894), u1894(1895), u1895(1896), u1896(1897), u1897(1898),  
u1898(1899), u1899(1900), u1900(1901), u1901(1902), u1902(1903), u1903(1904),  
u1904(1905), u1905(1906), u1906(1907), u1907(1908), u1908(1909), u1909(1910),  
u1910(1911), u1911(1912), u1912(1913), u1913(1914), u1914(1915), u1915(1916),  
u1916(1917), u1917(1918), u1918(1919), u1919(1920), u1920(1921), u1921(1922),  
u1922(1923), u1923(1924), u1924(1925), u1925(1926), u1926(1927), u1927(1928),  
u1928(1929), u1929(1930), u1930(1931), u1931(1932), u1932(1933), u1933(1934),  
u1934(1935), u1935(1936), u1936(1937), u1937(1938), u1938(1939), u1939(1940),  
u1940(1941), u1941(1942), u1942(1943), u1943(1944), u1944(1945), u1945(1946),  
u1946(1947), u1947(1948), u1948(1949), u1949(1950), u1950(1951), u1951(1952),  
u1952(1953), u1953(1954), u1954(1955), u1955(1956), u1956(1957), u1957(1958),  
u1958(1959), u1959(1960), u1960(1961), u1961(1962), u1962(1963), u1963(1964),  
u1964(1965), u1965(1966), u1966(1967), u1967(1968), u1968(1969), u1969(1970),  
u1970(1971), u1971(1972), u1972(1973), u1973(1974), u1974(1975), u1975(1976),  
u1976(1977), u1977(1978), u1978(1979), u1979(1980), u1980(1981), u1981(1982),  
u1982(1983), u1983(1984), u1984(1985), u1985(1986), u1986(1987), u1987(1988),  
u1988(1989), u1989(1990), u1990(1991), u1991(1992), u1992(1993), u1993(1994),  
u1994(1995), u1995(1996), u1996(1997), u1997(1998), u1998(1999), u1999(2000)

+-- -R-- String outputName(2)  
| Textual Convention: DisplayString

```

| | | Size: 1..4
| | | +-- -RW- Integer32 outputGroup(3)
| | | | Range: 0..1999
| | | +-- -R-- BitString outputStatus(4)
| | | | Values: outputOn(0), outputInhibit(1), outputFailureMinSenseVoltage(2),
| | | | | outputFailureMaxSenseVoltage(3), outputFailureMaxTerminalVoltage(4),
| | | | | outputFailureMaxCurrent(5), outputFailureMaxTemperature(6), outputFailureMaxPower(7),
| | | | | outputFailureTimeout(9), outputCurrentLimited(10), outputRampUp(11), outputRampDown(12)
| | | +-- -R-- Opaque outputMeasurementSenseVoltage(5)
| | | | Textual Convention: Float
| | | | Size: 7
| | | +-- -R-- Opaque outputMeasurementTerminalVoltage(6)
| | | | Textual Convention: Float
| | | | Size: 7
| | | +-- -R-- Opaque outputMeasurementCurrent(7)
| | | | Textual Convention: Float
| | | | Size: 7
| | | +-- -R-- EnumVal outputMeasurementTemperature(8)
| | | | Values: ok(-128), failure(127)
| | | +-- -RW- EnumVal outputSwitch(9)
| | | | Values: off(0), on(1)
| | | +-- -RW- Opaque outputVoltage(10)
| | | | Textual Convention: Float
| | | | Size: 7
| | | +-- -RW- Integer32 outputAdjustVoltage(11)
| | | | Range: -128..127
| | | +-- -RW- Opaque outputCurrent(12)
| | | | Textual Convention: Float
| | | | Size: 7
| | | +-- -RW- Opaque outputVoltageRiseRate(13)
| | | | Textual Convention: Float
| | | | Size: 7
| | | +-- -RW- Opaque outputVoltageFallRate(14)
| | | | Textual Convention: Float
| | | | Size: 7
| | | +-- -RW- Integer32 outputSupervisionBehavior(15)
| | | | Range: 0..65535
| | | +-- -RW- Opaque outputSupervisionMinSenseVoltage(16)
| | | | Textual Convention: Float
| | | | Size: 7
| | | +-- -RW- Opaque outputSupervisionMaxSenseVoltage(17)
| | | | Textual Convention: Float
| | | | Size: 7
| | | +-- -RW- Opaque outputSupervisionMaxTerminalVoltage(18)
| | | | Textual Convention: Float
| | | | Size: 7
| | | +-- -RW- Opaque outputSupervisionMaxCurrent(19)
| | | | Textual Convention: Float
| | | | Size: 7
| | | +-- -RW- Opaque outputConfigMaxSenseVoltage(21)
| | | | Textual Convention: Float
| | | | Size: 7
| | | +-- -RW- Opaque outputConfigMaxTerminalVoltage(22)
| | | | Textual Convention: Float
| | | | Size: 7
| | | +-- -RW- Opaque outputConfigMaxCurrent(23)
| | | | Textual Convention: Float
| | | | Size: 7
| | | +-- -RW- Opaque outputSupervisionMaxPower(24)
| | | | Textual Convention: Float
| | | | Size: 7
| | | +-- -R-- Integer32 groupsNumber(3)
| | | | Range: 1..1999

```

```

| |
| +--groupsTable(4)
| | |
| | +--groupsEntry(1)
| | | Index: groupsIndex
| | | |
| | | +-- ---- Integer32 groupsIndex(1)
| | | | Range: 0..1999
| | | +-- -RW- EnumVal groupsSwitch(9)
| | | | Values: undefined(-1), off(0), on(1)
| | |
| |
| +--sensor(4)
| | +-- -R-- Integer32 sensorNumber(1)
| | | Range: 0..8
| | |
| | |
| | +--sensorTable(2)
| | |
| | | +--sensorEntry(1)
| | | | Index: sensorIndex
| | | | |
| | | | +-- ---- EnumVal sensorIndex(1)
| | | | | Values: temp1(1), temp2(2), temp3(3), temp4(4), temp5(5), temp6(6), temp7(7), temp8(8)
| | | | +-- -R-- Integer32 sensorTemperature(2)
| | | | | Range: -128..127
| | | | +-- -RW- Integer32 sensorWarningThreshold(3)
| | | | | Range: 0..127
| | | | +-- -RW- Integer32 sensorFailureThreshold(4)
| | | | | Range: 0..127
| | | |
| | |
| |
| +--communication(5)
| | +--snmp(1)
| | |
| | | +--snmpCommunityTable(1)
| | | |
| | | | |
| | | | +--snmpCommunityEntry(1)
| | | | | Index: snmpAccessRight
| | | | | |
| | | | | +-- ---- EnumVal snmpAccessRight(1)
| | | | | | Values: public(1), private(2), admin(3), guru(4)
| | | | | +-- -RW- String snmpCommunityName(2)
| | | | | | Size: 0..14
| | | | |
| | | |
| | | +-- -RW- Integer32 snmpPort(2)
| | |
| |
| +--powersupply(6)
| | +-- -R-- String psSerialNumber(2)
| | | Textual Convention: DisplayString
| | | | Size: 0..255
| | |
| | +-- -R-- Integer32 psOperatingTime(3)
| | +-- -RW- String psDirectAccess(1024)
| | | Size: 1..14
| |
| |
| +--fantray(7)
| | +-- -RW- String fanSerialNumber(2)
| | | Textual Convention: DisplayString
| | | | Size: 0..14
| | |
| | +-- -R-- Integer32 fanOperatingTime(3)
| | +-- -R-- Integer32 fanAirTemperature(4)
| | +-- -RW- Integer32 fanSwitchOffDelay(5)
| | | Range: 0..900
| | +-- -RW- Integer32 fanNominalSpeed(6)
| | | Range: 0..3600
| | +-- -RW- Integer32 fanNumberOfFans(7)
| | | Range: 0..12
| |

```

```
| |
| |--fanSpeedTable(8)
| | |
| | |--fanSpeedEntry(1)
| | | | Index: fanNumber
| | | | |
| | | |-- Integer32 fanNumber(1)
| | | | | Range: 1..12
| | | |-- -R-- Integer32 fanSpeed(2)
| | |
| |--rack(8)
```